



MULHERN+KULP
RESIDENTIAL STRUCTURAL ENGINEERING

7220 Trade Street, Suite 350, San Diego, CA 92121 ▶ p 619-650-0010 ▶ mulhernkulp.com

CALCULATION PACKAGE

December 22, 2020

McCullough Architects

Barcelo Homes – Lot 1

7216 93rd Ave. SE
Mercer Island, WA

MULHERN & KULP STRUCTURAL ENGINEERING, INC.

Prepared By:

Nicholas J. Dastalfo

Project Engineer

Nicholas J. Martignetti, P.E.

Associate Owner + San Diego Office Director

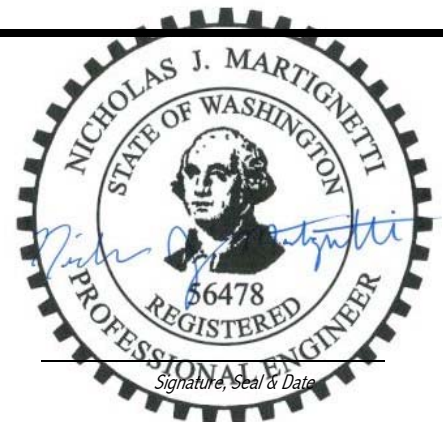



BEAM & HEADER CALCULATIONS

BEAM DESCRIPTION: ROOF FRMG - TYP. EXT. HDR - WORST CASE

B1

PARAMETERS:

L = 6.00 FT
W = 0.580 KLF
P = - K

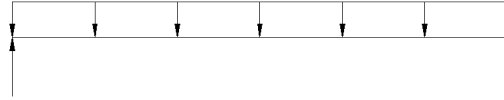

ANALYSIS:

$R_{MAX} = 1.740$ K $V_D = -$ K < $V_{ALL} = 4.470$ K ADEQUATE
 $M_{MAX} = 2.610$ K-FT < $M_{ALL} = 5.170$ K-FT ADEQUATE
 $\Delta_{TL} = 0.046$ IN. $L/1000+$ < $L/240$ ADEQUATE

4 x 10

BEAM DESCRIPTION: ROOF FRMG - SIDE MAST BD HDR

B2

PARAMETERS:

L = 6.00 FT
W = 0.530 KLF
P = - K

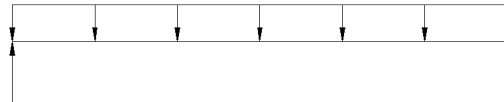

ANALYSIS:

$R_{MAX} = 1.590$ K $V_D = -$ K < $V_{ALL} = 3.400$ K ADEQUATE
 $M_{MAX} = 2.390$ K-FT < $M_{ALL} = 3.530$ K-FT ADEQUATE
 $\Delta_{TL} = 0.177$ IN. $L/407$ < $L/240$ ADEQUATE

3 1/2" x 5 1/2" GLB

BEAM DESCRIPTION: ROOF FRMG - TYP. EXT. HDR @ 6" DEPTH

B3

PARAMETERS:

L = 6.00 FT
W = 0.440 KLF
P = - K

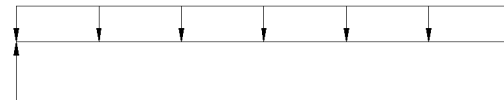

ANALYSIS:

$R_{MAX} = 1.320$ K $V_D = -$ K < $V_{ALL} = 4.180$ K ADEQUATE
 $M_{MAX} = 1.980$ K-FT < $M_{ALL} = 2.330$ K-FT ADEQUATE
 $\Delta_{TL} = 0.129$ IN. $L/558$ < $L/240$ ADEQUATE

6 x 6



BEAM & HEADER CALCULATIONS

BEAM DESCRIPTION: ROOF FRMG - CANTILEVERD BEAMS AT SPA @ EXT. WALL

B4

PARAMETERS:

L = 6.00 FT
W = 0.310 KLF
P = 0.780 K

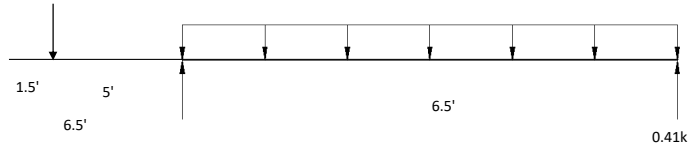

ANALYSIS:

$R_{MAX} = 2.390$ K $V_D = -$ K < $V_{ALL} = 16.760$ K ADEQUATE
 $M_{MAX} = 3.875$ K-FT < $M_{ALL} = 47.440$ K-FT ADEQUATE
 $\Delta_{TL} = 0.050$ IN. $L/1000+$ < $L/240$ ADEQUATE

5 1/2" x 15" GLB

BEAM DESCRIPTION: ROOF FRMG - CANTILEVERD BEAMS AT SPA @ RIDGE

B5

PARAMETERS:

L = 6.00 FT
W = 0.350 KLF
P = 0.860 K

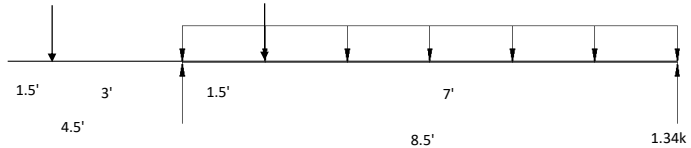

ANALYSIS:

$R_{MAX} = 3.360$ K $V_D = -$ K < $V_{ALL} = 16.760$ K ADEQUATE
 $M_{MAX} = 2.390$ K-FT < $M_{ALL} = 47.440$ K-FT ADEQUATE
 $\Delta_{TL} = 0.010$ IN. $L/1000+$ < $L/240$ ADEQUATE

5 1/2" x 15" GLB

BEAM DESCRIPTION: ROOF FRMG - FASCIA BM AT SPA

B6

PARAMETERS:

L = SHOWN FT
W = 0.090 KLF
P = - K

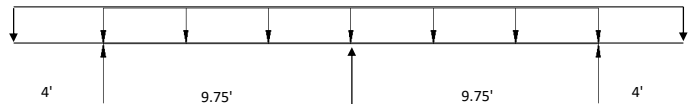

ANALYSIS:

$R_{MAX} = 0.880$ K $V_D = -$ K < $V_{ALL} = 3.950$ K ADEQUATE
 $M_{MAX} = 1.070$ K-FT < $M_{ALL} = 8.930$ K-FT ADEQUATE
 $\Delta_{TL} = 0.040$ IN. $L/1000+$ < $L/240$ ADEQUATE

1 3/4" x 11 7/8" LVL



BEAM & HEADER CALCULATIONS

BEAM DESCRIPTION: ROOF FRMG - RAFTER BM @ SPA SIDE WALL

B7

PARAMETERS:

L = FT
W = KLF
P = K

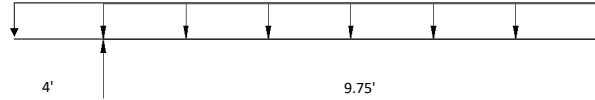

ANALYSIS:

$R_{MAX} =$ K $V_D =$ K < $V_{ALL} =$ K ADEQUATE
 $M_{MAX} =$ K-FT < $M_{ALL} =$ K-FT ADEQUATE
 $\Delta_{TL} =$ IN. $L/$ < $L/240$ ADEQUATE

BEAM DESCRIPTION: ROOF FRMG - FLUSH BM AT HIGH ROOF ABOVE STAIRS

B8

PARAMETERS:

L = FT
W = KLF
P = K

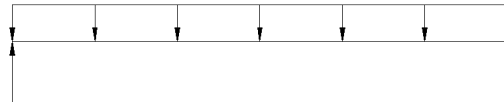

ANALYSIS:

$R_{MAX} =$ K $V_D =$ K < $V_{ALL} =$ K ADEQUATE
 $M_{MAX} =$ K-FT < $M_{ALL} =$ K-FT ADEQUATE
 $\Delta_{TL} =$ IN. $L/$ < $L/240$ ADEQUATE

BEAM DESCRIPTION: ROOF FRMG - FLUSH BM AT STAIRS/BD#4

B9

PARAMETERS:

L = FT
W = KLF
P = K

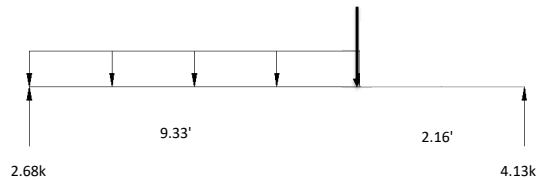

ANALYSIS:

$R_{MAX} =$ K $V_D =$ K < $V_{ALL} =$ K ADEQUATE
 $M_{MAX} =$ K-FT < $M_{ALL} =$ K-FT ADEQUATE
 $\Delta_{TL} =$ IN. $L/$ < $L/240$ ADEQUATE



BEAM & HEADER CALCULATIONS

BEAM DESCRIPTION: ROOF FRMG - FLUSH BM ABOVE BATH #2

B 1 0

PARAMETERS:

L = 16.00 FT
W = 0.490 KLF
P = - K

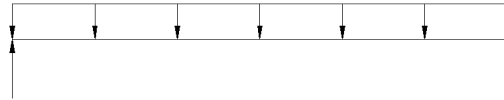

ANALYSIS:

$R_{MAX} = 3.920$ K $V_D = -$ K < $V_{ALL} = 11.850$ K ADEQUATE
 $M_{MAX} = 15.680$ K-FT < $M_{ALL} = 26.780$ K-FT ADEQUATE
 $\Delta_{TL} = 0.494$ IN. $L/389 < L/240$ ADEQUATE

5 1/4" x 11 7/8" LVL

BEAM DESCRIPTION: ROOF FRMG - CANT BM @ TOP OF ROOF TOP DECK STAIRS

B 1 1

PARAMETERS:

L = SHOWN FT
W = 0.230 KLF
P = SHOWN K

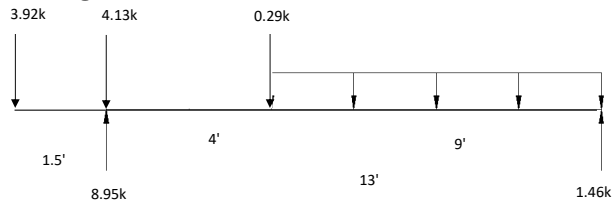

ANALYSIS:

$R_{MAX} = 4.820$ K $V_D = -$ K < $V_{ALL} = 7.900$ K ADEQUATE
 $M_{MAX} = 5.890$ K-FT < $M_{ALL} = 17.850$ K-FT ADEQUATE
 $\Delta_{TL} = 0.054$ IN. $L/660 < L/240$ ADEQUATE

3 1/2" x 11 7/8" LVL

BEAM DESCRIPTION: ROOF FRMG - FLUSH BM AT STAIRS/BD#4

B 1 2

PARAMETERS:

L = SHOWN FT
W = 0.490 KLF
P = 0.230 K

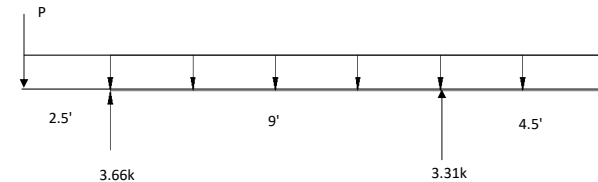

ANALYSIS:

$R_{MAX} = 3.660$ K $V_D = -$ K < $V_{ALL} = 7.900$ K ADEQUATE
 $M_{MAX} = 4.960$ K-FT < $M_{ALL} = 17.850$ K-FT ADEQUATE
 $\Delta_{TL} = 0.148$ IN. $L/730 < L/240$ ADEQUATE

3 1/2" x 11 7/8" LVL



BEAM & HEADER CALCULATIONS

BEAM DESCRIPTION: ROOF FRMG - CANT BM AT ROOF TOP DECK

B 13

PARAMETERS:

L = **SHOWN** FT
W = **0.095** KLF
P = **3.660** K

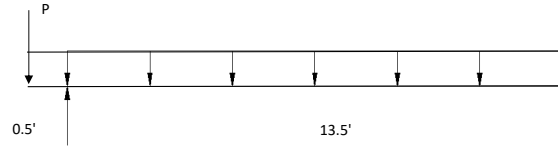

ANALYSIS:

$R_{MAX} = 4.490$ K $V_D = -$ K < $V_{ALL} = 7.900$ K ADEQUATE
 $M_{MAX} = 1.850$ K-FT < $M_{ALL} = 17.850$ K-FT ADEQUATE
 $\Delta_{TL} = 0.010$ IN. $L/1000 < L/240$ ADEQUATE

3 1/2" x 11 7/8" LVL

BEAM DESCRIPTION: ROOF FRMG - CANT BM @ TOP OF ROOF TOP DECK STAIRS

B 14

PARAMETERS:

L = **SHOWN** FT
W = **0.050** KLF
P = **-** K

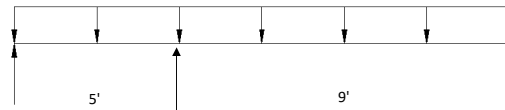

ANALYSIS:

$R_{MAX} = 0.350$ K $V_D = -$ K < $V_{ALL} = 3.950$ K ADEQUATE
 $M_{MAX} = 0.510$ K-FT < $M_{ALL} = 8.930$ K-FT ADEQUATE
 $\Delta_{TL} = 0.010$ IN. $L/1000 < L/240$ ADEQUATE

1 3/4" x 11 7/8" LVL

BEAM DESCRIPTION: ROOF FRMG -CANT DROPPED BM @ BD#4 SIDE WALLS

B 15

PARAMETERS:

L = **SHOWN** FT
W = **0.360** KLF
P = **0.750** K

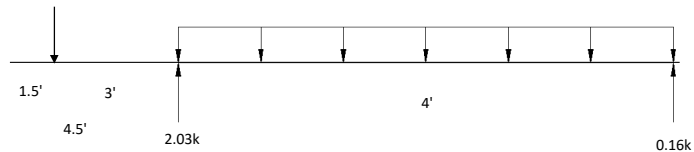

ANALYSIS:

$R_{MAX} = 2.030$ K $V_D = -$ K < $V_{ALL} = 16.760$ K ADEQUATE
 $M_{MAX} = 2.250$ K-FT < $M_{ALL} = 47.440$ K-FT ADEQUATE
 $\Delta_{TL} = 0.148$ IN. $L/730 < L/240$ ADEQUATE

5 1/2" x 15" GLB



BEAM & HEADER CALCULATIONS

BEAM DESCRIPTION: ROOF FRMG - GANT DROPPED BM @ BD#4

B16

PARAMETERS:

L = FT
W = KLF
P = K

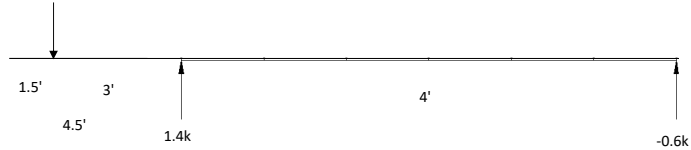

ANALYSIS:

$R_{MAX} = 1.400$ K $V_D = -$ K < $V_{ALL} = 16.760$ K ADEQUATE
 $M_{MAX} = 2.400$ K-FT < $M_{ALL} = 47.440$ K-FT ADEQUATE
 $\Delta_{TL} = 0.050$ IN. $L/1000 < L/240$ ADEQUATE

BEAM DESCRIPTION: ROOF FRMG - BD#4 FRONT WINDOW HDR

B17

PARAMETERS:

L = FT
W = KLF
P = K

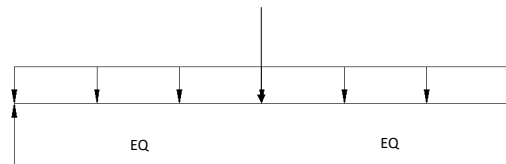

ANALYSIS:

$R_{MAX} = 0.970$ K $V_D = -$ K < $V_{ALL} = 4.470$ K ADEQUATE
 $M_{MAX} = 2.510$ K-FT < $M_{ALL} = 5.170$ K-FT ADEQUATE
 $\Delta_{TL} = 0.040$ IN. $L/1000+ < L/240$ ADEQUATE

BEAM DESCRIPTION: 2ND FLR FRMG - DROPPED BM AT SIDE DECK BY GRILL & FIREPLACE

B18

PARAMETERS:

L = FT
W = KLF
P = K

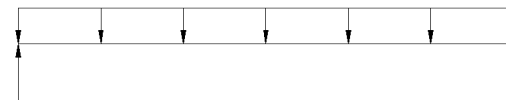

ANALYSIS:

$R_{MAX} = 0.810$ K $V_D = -$ K < $V_{ALL} = 8.530$ K ADEQUATE
 $M_{MAX} = 1.580$ K-FT < $M_{ALL} = 19.320$ K-FT ADEQUATE
 $\Delta_{TL} = 0.020$ IN. $L/1000+ < L/240$ ADEQUATE



BEAM & HEADER CALCULATIONS

BEAM DESCRIPTION:

2ND FLR FRMG - CANT DROPPED BM AT SIDE DECK BY GRILL & FIREPLACE

B19

PARAMETERS:

L = FT
W = KLF
P = K

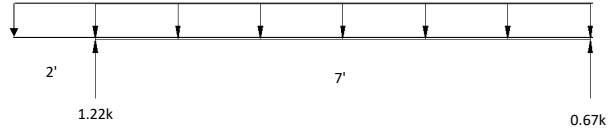

ANALYSIS:

$R_{MAX} = 1.220$ K $V_D = -$ K < $V_{ALL} = 8.530$ K ADEQUATE
 $M_{MAX} = 1.290$ K-FT < $M_{ALL} = 19.320$ K-FT ADEQUATE
 $\Delta_{TL} = 0.010$ IN. $L/1000+$ < $L/240$ ADEQUATE

3 1/2" x 12" GLB

BEAM DESCRIPTION:

2ND FLR FRMG - FLUSH BEAM BELOW MASTER BALCONY

B20

PARAMETERS:

L = FT
W = KLF
P = K

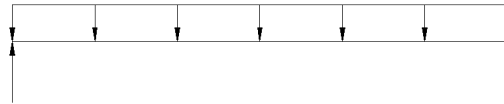

ANALYSIS:

$R_{MAX} = 3.270$ K $V_D = -$ K < $V_{ALL} = 10.670$ K ADEQUATE
 $M_{MAX} = 13.330$ K-FT < $M_{ALL} = 30.190$ K-FT ADEQUATE
 $\Delta_{TL} = 0.361$ IN. $L/543$ < $L/240$ ADEQUATE

3 1/2" x 15" GLB

BEAM DESCRIPTION:

2ND FLR FRMG - DINING ROOM SGD HDR

B21

PARAMETERS:

L = FT
W = KLF
P = K

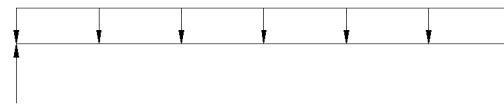

ANALYSIS:

$R_{MAX} = 9.450$ K $V_D = -$ K < $V_{ALL} = 21.790$ K ADEQUATE
 $M_{MAX} = 35.440$ K-FT < $M_{ALL} = 80.170$ K-FT ADEQUATE
 $\Delta_{TL} = 0.235$ IN. $L/766$ < $L/240$ ADEQUATE

5 1/2" x 19 1/2" GLB



BEAM & HEADER CALCULATIONS

BEAM DESCRIPTION: 2ND FLR FRMG - TYP. HEADER - WORST CASE LOAD

B22

PARAMETERS:

L = 5.50 FT
W = 0.935 KLF
P = - K



ANALYSIS:

$R_{MAX} = 2.570$ K $V_D = -$ K < $V_{ALL} = 5.690$ K ADEQUATE
 $M_{MAX} = 3.540$ K-FT < $M_{ALL} = 4.320$ K-FT ADEQUATE
 $\Delta_{TL} = 0.077$ IN. L/ 857 < L/240 ADEQUATE

6 x 8

BEAM DESCRIPTION: 2ND FLR FRMG - TYP. HEADER - WORST CASE SPAN

B22

PARAMETERS:

L = 6.00 FT
W = 0.800 KLF
P = - K

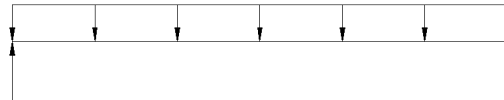

ANALYSIS:

$R_{MAX} = 2.400$ K $V_D = -$ K < $V_{ALL} = 5.690$ K ADEQUATE
 $M_{MAX} = 3.600$ K-FT < $M_{ALL} = 4.320$ K-FT ADEQUATE
 $\Delta_{TL} = 0.093$ IN. L/ 776 < L/240 ADEQUATE

6 x 8

BEAM DESCRIPTION: 2ND FLR FRMG - DINING ROOM SBD HDR

B23

PARAMETERS:

L = 18.00 FT
W = 0.600 KLF
P = - K

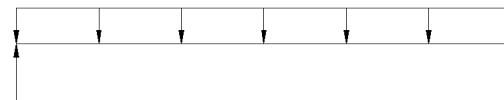

ANALYSIS:

$R_{MAX} = 5.400$ K $V_D = -$ K < $V_{ALL} = 49.000$ K ADEQUATE
 $M_{MAX} = 24.300$ K-FT < $M_{ALL} = 64.900$ K-FT ADEQUATE
 $\Delta_{TL} = 0.414$ IN. L/ 521 < L/240 ADEQUATE

W10 x 22



BEAM & HEADER CALCULATIONS

BEAM DESCRIPTION:

2ND FLR FRMG - FLUSH BM ALTERNATE AT STAIRS

B24

PARAMETERS:

L = **12.00** FT
W = **SHOWN** KLF
P = **SHOWN** K

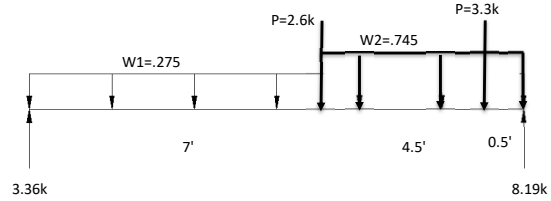

ANALYSIS:

$R_{MAX} = 8.190$ K $V_D = -$ K < $V_{ALL} = 11.130$ K ADEQUATE
 $M_{MAX} = 16.780$ K-FT < $M_{ALL} = 37.800$ K-FT ADEQUATE
 $\Delta_{TL} = 0.142$ IN. L/ **1000+** < L/240 ADEQUATE

3 1/2" X 18" GLB OR FLOOR GT

BEAM DESCRIPTION:

2ND FLR FRMG - FLUSH BM ALTERNATE AT POWDER RM

B25

PARAMETERS:

L = **SHOWN** FT
W = **0.730** KLF
P = **-** K

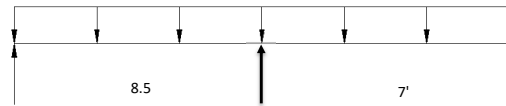

ANALYSIS:

$R_{MAX} = 5.660$ K $V_D = -$ K < $V_{ALL} = 7.170$ K ADEQUATE
 $M_{MAX} = 6.590$ K-FT < $M_{ALL} = 8.840$ K-FT ADEQUATE
 $\Delta_{TL} = 0.100$ IN. L/ **1000+** < L/240 ADEQUATE

6 X 12

BEAM DESCRIPTION:

2ND FLR FRMG - FLUSH BM ALT. AT REAR OF GARAGE

B26

PARAMETERS:

L = **11.00** FT
W = **0.850** KLF
P = **-** K

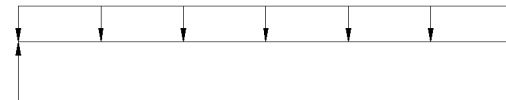

ANALYSIS:

$R_{MAX} = 4.680$ K $V_D = -$ K < $V_{ALL} = 11.730$ K ADEQUATE
 $M_{MAX} = 12.860$ K-FT < $M_{ALL} = 23.240$ K-FT ADEQUATE
 $\Delta_{TL} = 0.293$ IN. L/ **450** < L/240 ADEQUATE

5 1/2" X 10 1/2" GLB



BEAM & HEADER CALCULATIONS

BEAM DESCRIPTION: 2ND FLR FRMG - FLUSH BEAM ABOVE GARAGE

B27

PARAMETERS:

L = 8.00 FT
W = 0.100 KLF
P = 1.000 K

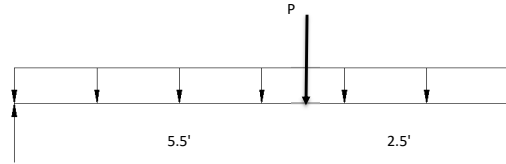

ANALYSIS:

$R_{MAX} = 1.090$ K $V_D = -$ K < $V_{ALL} = 5.990$ K ADEQUATE
 $M_{MAX} = 2.400$ K-FT < $M_{ALL} = 19.380$ K-FT ADEQUATE
 $\Delta_{TL} = 0.020$ IN. $L/1000+$ < $L/240$ ADEQUATE

1 3/4" x 18" LVL

BEAM DESCRIPTION: 2ND FLR FRMG - GARAGE FLUSH BM

B28

PARAMETERS:

L = 22.00 FT
W = 0.730 KLF
P = 3.500 K

SEE
OVERSTRENGTH
CALCS FOR MORE
INFORMATION

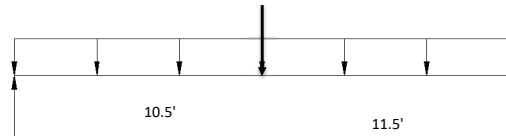

ANALYSIS:

$R_{MAX} = -$ K $V_D = -$ K < $V_{ALL} = -$ K ADEQUATE
 $M_{MAX} = -$ K-FT < $M_{ALL} = -$ K-FT ADEQUATE
 $\Delta_{TL} = -$ IN. $L/-$ < $L/240$ ADEQUATE

5 1/2" x 22 1/2" GLB

BEAM DESCRIPTION: 2ND FLR FRMG - DECK JOISTS AT MASTER BALCONY

B29

PARAMETERS:

L = 8.00 FT
W = 0.115 KLF
P = - K

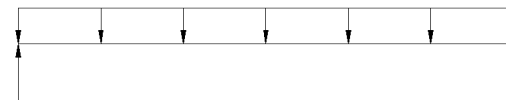

ANALYSIS:

$R_{MAX} = 0.460$ K $V_D = -$ K < $V_{ALL} = 0.830$ K ADEQUATE
 $M_{MAX} = 0.920$ K-FT < $M_{ALL} = 1.280$ K-FT ADEQUATE
 $\Delta_{TL} = 0.171$ IN. $L/561$ < $L/240$ ADEQUATE

2x8 HF #2 @ 16"o.c.



BEAM & HEADER CALCULATIONS

BEAM DESCRIPTION: 2ND FLR FRMG - FASCIA BEAM IN FRONT OF GARAGE

B30

PARAMETERS:

L = 22.50 FT
W = 0.120 KLF
P = - K



ANALYSIS:

$R_{MAX} = 1.350$ K $V_D = -$ K < $V_{ALL} = 13.410$ K ADEQUATE
 $M_{MAX} = 7.590$ K-FT < $M_{ALL} = 30.360$ K-FT ADEQUATE
 $\Delta_{TL} = 0.485$ IN. $L/557 < L/240$ ADEQUATE

5 1/2" X 12" GLB

BEAM DESCRIPTION: 1ST FLR FRMG - DROPPED BM AT DECK BELOW FP

B31

PARAMETERS:

L = 8.75 FT
W = 0.910 KLF
P = - K

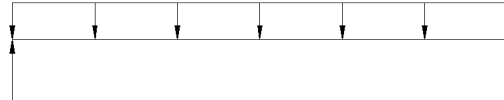

ANALYSIS:

$R_{MAX} = 3.980$ K $V_D = -$ K < $V_{ALL} = 7.170$ K ADEQUATE
 $M_{MAX} = 8.710$ K-FT < $M_{ALL} = 8.840$ K-FT ADEQUATE
 $\Delta_{TL} = 0.133$ IN. $L/789 < L/240$ ADEQUATE

6 X 12

BEAM DESCRIPTION: 1ST FLR FRMG - FLUSH @ EDGE OF DECK

B32

PARAMETERS:

L = 16.50 FT
W = 0.080 KLF
P = SHOWN K

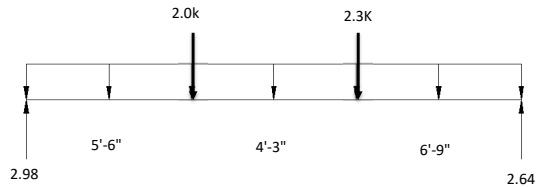

ANALYSIS:

$R_{MAX} = 2.980$ K $V_D = -$ K < $V_{ALL} = 10.670$ K ADEQUATE
 $M_{MAX} = 16.000$ K-FT < $M_{ALL} = 30.190$ K-FT ADEQUATE
 $\Delta_{TL} = 0.443$ IN. $L/447 < L/240$ ADEQUATE

3 1/2" X 15" GLB



BEAM & HEADER CALCULATIONS

BEAM DESCRIPTION: 1ST FLR FRMG - FLUSH BM AT EDGE OF DECK, PERP TO DJ

B33

PARAMETERS:

L = **SHOWN** FT
W = **0.640** KLF
P = **-** K

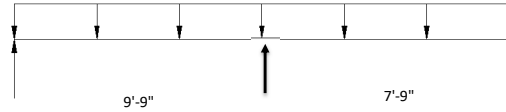

ANALYSIS:

R_{MAX} = **5.600** K V_D = **-** K < V_{ALL} = **9.280** K ADEQUATE
M_{MAX} = **7.610** K-FT < M_{ALL} = **26.250** K-FT ADEQUATE
Δ_{TL} = **0.074** IN. L/ **1000+** < L/240 ADEQUATE

3 1/2" x 15" GLB

BEAM DESCRIPTION: 1ST FLR FRMG - REC ROOM SGD HDR

B34

PARAMETERS:

L = **15.00** FT
W = **0.710** KLF
P = **-** K

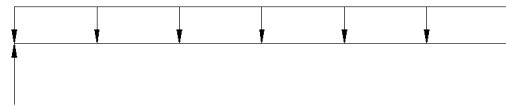

ANALYSIS:

R_{MAX} = **5.330** K V_D = **-** K < V_{ALL} = **16.030** K ADEQUATE
M_{MAX} = **19.970** K-FT < M_{ALL} = **49.910** K-FT ADEQUATE
Δ_{TL} = **0.218** IN. L/ **826** < L/240 ADEQUATE

5 1/2" x 16 1/2" GLB

BEAM DESCRIPTION: 1ST FLR FRMG - INTERIOR HDR AT BATH

B35

PARAMETERS:

L = **3.00** FT
W = **1.080** KLF
P = **-** K

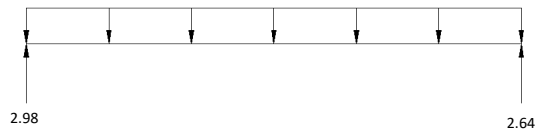

ANALYSIS:

R_{MAX} = **1.620** K V_D = **-** K < V_{ALL} = **3.050** K ADEQUATE
M_{MAX} = **1.220** K-FT < M_{ALL} = **2.990** K-FT ADEQUATE
Δ_{TL} = **0.010** IN. L/ **1000+** < L/240 ADEQUATE

4 x 8



BEAM & HEADER CALCULATIONS

BEAM DESCRIPTION: 1ST FLR FRMG - FLUSH BEAM AT STAIRS

B36

PARAMETERS:

L = 5.25 FT
W = 0.970 KLF
P = 12.050 K

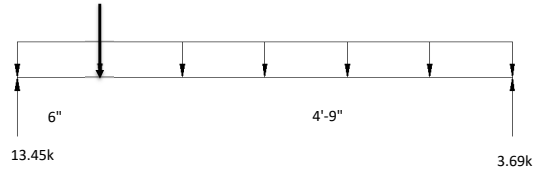

ANALYSIS:

$R_{MAX} = 13.450$ K $V_D = 7.030$ K < $V_{ALL} = 11.660$ K ADEQUATE
 $M_{MAX} = 7.020$ K-FT < $M_{ALL} = 26.400$ K-FT ADEQUATE
 $\Delta_{TL} = 0.024$ IN. $L/1000+$ < $L/240$ ADEQUATE

5 1/2" x 12" GLB

BEAM DESCRIPTION: 1ST FLR FRMG - 2X DECK JOISTS

B37

PARAMETERS:

L = 14.00 FT
W = 0.095 KLF
P = - K

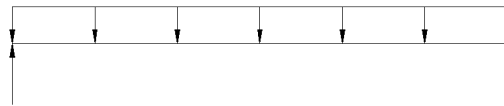

ANALYSIS:

$R_{MAX} = 0.665$ K $V_D = -$ K < $V_{ALL} = 1.690$ K ADEQUATE
 $M_{MAX} = 2.330$ K-FT < $M_{ALL} = 2.580$ K-FT ADEQUATE
 $\Delta_{TL} = 0.355$ IN. $L/473$ < $L/240$ ADEQUATE

2 x 12 HF #2 @ 16" O.C.

BEAM DESCRIPTION: 1ST FLR FRMG - CANT BM ALT. AT GREAT RM BELOW PIANO

B38

PARAMETERS:

L = SHOWN FT
W = SHOWN KLF
P = - K

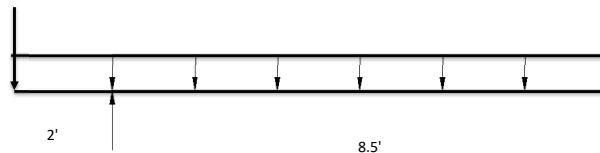

SEE OVERSTRENGTH CALCS FOR MORE INFO

ANALYSIS:

$R_{MAX} = -$ K $V_D = -$ K < $V_{ALL} = -$ K ADEQUATE
 $M_{MAX} = -$ K-FT < $M_{ALL} = -$ K-FT ADEQUATE
 $\Delta_{TL} = -$ IN. $L/-$ < $L/240$ ADEQUATE

1 3/4" x 24" GLB



BEAM & HEADER CALCULATIONS

BEAM DESCRIPTION: *1ST FLR FRMG - GANT BM ALT. AT GREAT RM BELOW PIANO*

B39

PARAMETERS:

L = FT
W = KLF
P = K



ANALYSIS:

SEE OVERSTRENGTH CALCS FOR MORE INFO

$R_{MAX} =$ K $V_D =$ K < $V_{ALL} =$ K ADEQUATE
 $M_{MAX} =$ K-FT < $M_{ALL} =$ K-FT ADEQUATE
 $\Delta_{TL} =$ IN. $L/$ < $L/240$ ADEQUATE

BEAM DESCRIPTION: *1ST FLR FRMG - FLUSH BM ALT. AT STAIRS*

B40

PARAMETERS:

L = FT
W = KLF
P = K

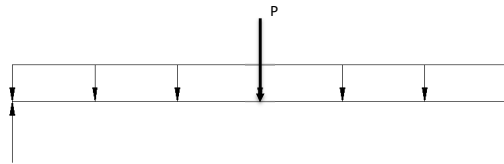

ANALYSIS:

$R_{MAX} =$ K $V_D =$ K < $V_{ALL} =$ K ADEQUATE
 $M_{MAX} =$ K-FT < $M_{ALL} =$ K-FT ADEQUATE
 $\Delta_{TL} =$ IN. $L/$ < $L/240$ ADEQUATE

BEAM DESCRIPTION:

PARAMETERS:

L = FT
W = KLF
P = K

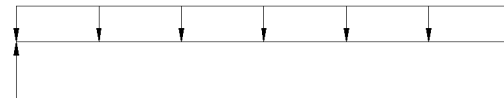

ANALYSIS:

$R_{MAX} =$ K $V_D =$ K < $V_{ALL} =$ K ADEQUATE
 $M_{MAX} =$ K-FT < $M_{ALL} =$ K-FT ADEQUATE
 $\Delta_{TL} =$ IN. $L/$ < $L/240$ ADEQUATE

OVERSTRENGTH CALCULATIONS

WALL DESCRIPTION/SW #:

204

PARAMETERS:

L = 11.5 FT
 H = 8.8 FT
 E = 1.70 K
 W_{DL WALL} = 0.10 KLF
 W_{DL} = 0.245 KLF
 Ω₀ = 2.5 (ASCE TABLE 12.2.1 FOOTNOTE G)
 SDS = 0.968

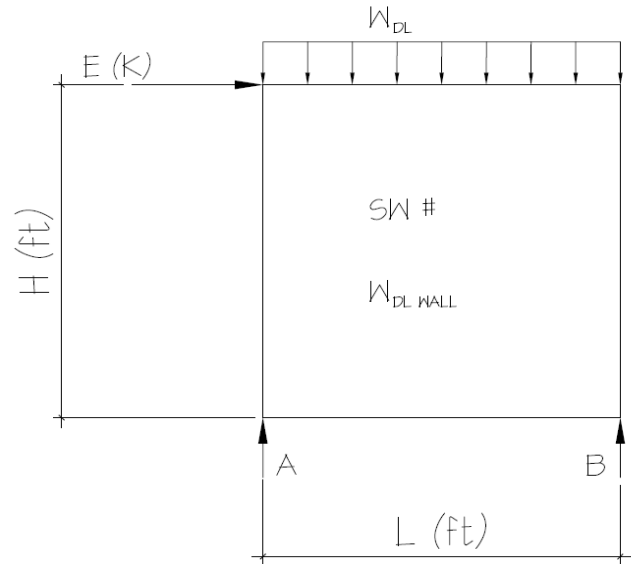

ANALYSIS:

$E_{MH} = \Omega_0 * E = 4.25$ K $E_v = 0.2 * SDS * DL = 0.768$ K
 $E_M = E_{MH} + E_v = 5.018$ K
 $E_M = E_{MH} - E_v = 3.482$ K

$E_M (MAX) = \sum M_A = 0 = 5.02(8.8) + 0.345(11.5)(5.75) - R_B(11.5)$ $R_B = 2.0DL + 3.9E$
 $R_A = 2.0DL - 3.9E$

$E_M (MIN) = \sum M_A = 0 = 3.48(8.8) + 0.345(11.5)(5.75) - R_B(11.5)$ $R_B = 2.0DL + 2.7E$
 $R_A = 2.0DL - 2.7E$

CHECK BEAMS FOR AXIAL FORCES SHOWN USING LOAD COMBOS PER SECTION 12.4.3.1 (ASD)

ALLOWABLE STRESS PERMITTED TO BE INCREASED BY 1.2

SEE FOLLOWING BEAM
CALCS FOR LOAD
APPLICATION

OVERSTRENGTH CALCULATIONS

WALL DESCRIPTION/SW #:

205

PARAMETERS:

- L = 7.3 FT
- H = 10.1 FT
- E = 1.00 K
- W_{DL WALL} = 0.10 KLF
- W_{DL} = 0.000 KLF
- Ω₀ = 2.5 (ASCE TABLE 12.2.1 FOOTNOTE G)
- SDS = 0.968

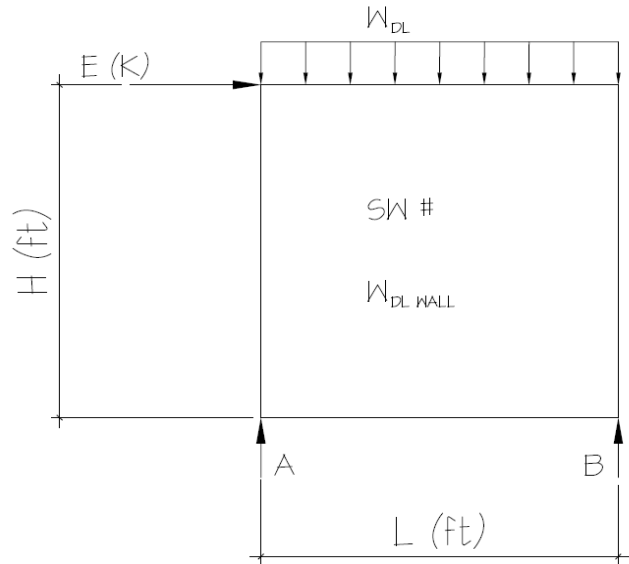

ANALYSIS:

$E_{MH} = \Omega_0 * E = 2.50 \text{ K}$ $E_v = 0.2 * SDS * DL = 0.142 \text{ K}$
 $E_M = E_{MH} + E_v = 2.642 \text{ K}$
 $E_M = E_{MH} - E_v = 2.358 \text{ K}$

$E_M (\text{MAX}) = \sum M_A = 0 = 2.64(10.1) + 0.1(7.33)(3.665) - R_B(7.33)$ $R_B = 0.4DL + 3.6E$
 $R_A = 0.4DL - 3.6E$

$E_M (\text{MIN}) = \sum M_A = 0 = 2.36(10.1) + 0.1(7.33)(3.665) - R_B(7.33)$ $R_B = 0.4DL + 3.2E$
 $R_A = 0.4DL - 3.2E$

CHECK BEAMS FOR AXIAL FORCES SHOWN USING LOAD COMBOS PER SECTION 12.4.3.1 (ASD)

ALLOWABLE STRESS PERMITTED TO BE INCREASED BY 1.2

SEE FOLLOWING BEAM
CALCS FOR LOAD
APPLICATION

OVERSTRENGTH CALCULATIONS

WALL DESCRIPTION/SW #:

206

PARAMETERS:

- L = 18.3 FT
- H = 8.8 FT
- E = 2.60 K
- W_{DL WALL} = 0.10 KLF
- W_{DL} = 0.105 KLF
- Ω₀ = 2.5 (ASCE TABLE 12.2.1 FOOTNOTE G)
- SDS = 0.968

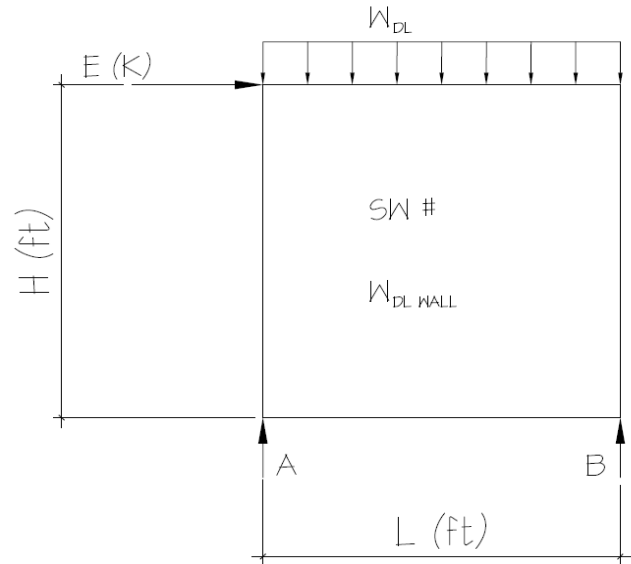

ANALYSIS:

$E_{MH} = \Omega_0 * E = 6.50 \text{ K}$ $E_v = 0.2 * SDS * DL = 0.724 \text{ K}$
 $E_M = E_{MH} + E_v = 7.224 \text{ K}$
 $E_M = E_{MH} - E_v = 5.776 \text{ K}$

$E_M (\text{MAX}) = \sum M_A = 0 = 7.22(8.8) + 0.205(18.25)(9.125) - R_B(18.25)$ $R_B = 1.9DL + 3.5E$
 $R_A = 1.9DL - 3.5E$
 $E_M (\text{MIN}) = \sum M_A = 0 = 5.78(8.8) + 0.205(18.25)(9.125) - R_B(18.25)$ $R_B = 1.9DL + 2.8E$
 $R_A = 1.9DL - 2.8E$

CHECK BEAMS FOR AXIAL FORCES SHOWN USING LOAD COMBOS PER SECTION 12.4.3.1 (ASD)

ALLOWABLE STRESS PERMITTED TO BE INCREASED BY 1.2

SEE FOLLOWING BEAM
CALCS FOR LOAD
APPLICATION

OVERSTRENGTH CALCULATIONS

WALL DESCRIPTION/SW #:

208

PARAMETERS:

L = 13.0 FT
 H = 9.5 FT
 E = 2.00 K
 W_{DL WALL} = 0.10 KLF
 W_{DL} = 0.000 KLF
 Ω₀ = 2.5 (ASCE TABLE 12.2.1 FOOTNOTE G)
 SDS = 0.968

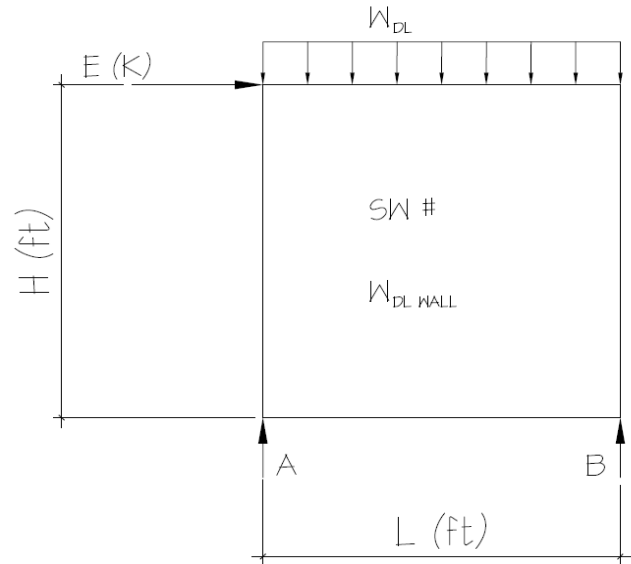

ANALYSIS:

$E_{MH} = \Omega_0 * E = 5.00$ K $E_v = 0.2 * SDS * DL = 0.252$ K
 $E_M = E_{MH} + E_v = 5.252$ K
 $E_M = E_{MH} - E_v = 4.748$ K

$E_M (MAX) = \sum M_A = 0 = 5.25(9.5) + 0.1(13)(6.5) - R_B(13)$ $R_B = 0.7DL + 3.8E$
 $R_A = 0.7DL - 3.8E$

$E_M (MIN) = \sum M_A = 0 = 4.75(9.5) + 0.1(13)(6.5) - R_B(13)$ $R_B = 0.7DL + 3.5E$
 $R_A = 0.7DL - 3.5E$

CHECK BEAMS FOR AXIAL FORCES SHOWN USING LOAD COMBOS PER SECTION 12.4.3.1 (ASD)

ALLOWABLE STRESS PERMITTED TO BE INCREASED BY 1.2

SEE FOLLOWING BEAM
CALCS FOR LOAD
APPLICATION

OVERSTRENGTH CALCULATIONS

WALL DESCRIPTION/SW #:

103

PARAMETERS:

- L = 9.0 FT
- H = 11.5 FT
- E = 2.10 K
- W_{DL WALL} = 0.10 KLF
- W_{DL} = 0.210 KLF
- Ω₀ = 2.5 (ASCE TABLE 12.2.1 FOOTNOTE G)
- SDS = 0.968

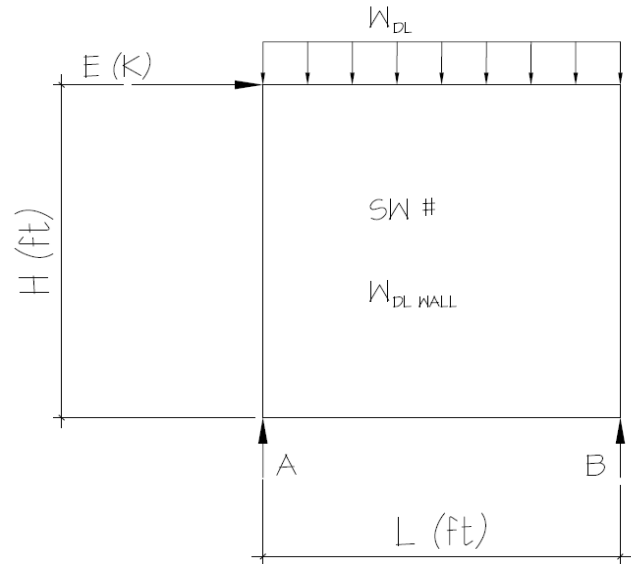

ANALYSIS:

$E_{MH} = \Omega_0 * E = 5.25 \text{ K}$ $E_v = 0.2 * SDS * DL = 0.540 \text{ K}$
 $E_M = E_{MH} + E_v = 5.790 \text{ K}$
 $E_M = E_{MH} - E_v = 4.710 \text{ K}$

$E_M \text{ (MAX)} = \sum M_A = 0 = 5.79(11.5) + 0.31(9)(4.5) - R_B(9)$ $R_B = 1.4DL + 7.4E$
 $R_A = 1.4DL - 7.4E$

$E_M \text{ (MIN)} = \sum M_A = 0 = 4.71(11.5) + 0.31(9)(4.5) - R_B(9)$ $R_B = 1.4DL + 6.0E$
 $R_A = 1.4DL - 6.0E$

CHECK BEAMS FOR AXIAL FORCES SHOWN USING LOAD COMBOS PER SECTION 12.4.3.1 (ASD)

ALLOWABLE STRESS PERMITTED TO BE INCREASED BY 1.2

SEE FOLLOWING BEAM
CALCS FOR LOAD
APPLICATION

Project Title:
 Engineer:
 Project ID:
 Project Descr:

Wood Beam

File = P:\CYJ7GB-PI2DNY94-NI2020I2S8Q79-7\Design\Gravity\Overstrength.ec6 .
 Software copyright ENERCALC, INC. 1983-2018, Build:10.18.12.13 .

Lic. #: KW-06004787

Licensee: MULHERN & KULP STRUCTURAL ENGINEERING INC

Description: B28 - Flush Beam at Garage

CODE REFERENCES

Calculations per NDS 2015, IBC 2015, CBC 2016, ASCE 7-10

Load Combination Set: ASCE 7-10

Material Properties

Analysis Method: Allowable Stress Design
 Load Combination: ASCE 7-10

Wood Species: DF/DF
 Wood Grade: 24F - V8

Beam Bracing: Beam is Fully Braced against lateral-torsional buckling

Fb + 2,880.0 psi
 Fb - 2,880.0 psi
 Fc - Prll 1,980.0 psi
 Fc - Perp 780.0 psi
 Fv 318.0 psi
 Ft 1,320.0 psi

E : Modulus of Elasticity
 Ebend- xx 1,800.0 ksi
 Eminbend- xx 950.0 ksi
 Ebend- yy 1,600.0 ksi
 Eminbend- yy 850.0 ksi
 Density 31.210pcf

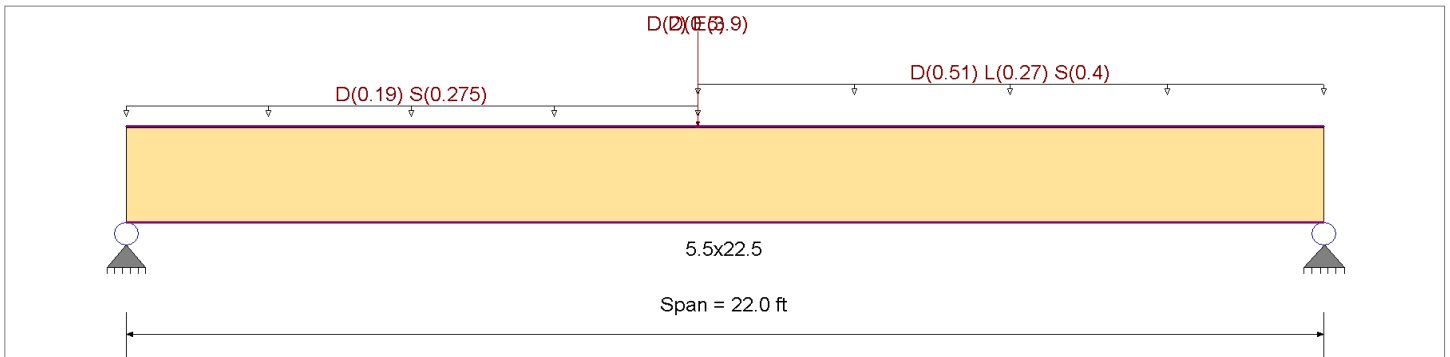

Applied Loads

Service loads entered. Load Factors will be applied for calculations.

Beam self weight calculated and added to loads

Point Load: D = 2.0, E = 3.90 k @ 10.50 ft

Uniform Load: D = 0.190, S = 0.2750 k/ft, Extent = 0.0 ---> 10.50 ft, Tributary Width = 1.0 ft

Uniform Load: D = 0.510, L = 0.270, S = 0.40 k/ft, Extent = 10.50 ---> 22.0 ft, Tributary Width = 1.0 ft

Point Load: D = 0.50 k @ 10.50 ft

DESIGN SUMMARY

DESIGN SUMMARY				Design OK			
Maximum Bending Stress Ratio	=	0.497	: 1	Maximum Shear Stress Ratio	=	0.304	: 1
Section used for this span		5.5x22.5		Section used for this span		5.5x22.5	
fb : Actual	=	1,527.66	psi	fv : Actual	=	111.06	psi
FB : Allowable	=	3,073.99	psi	Fv : Allowable	=	365.70	psi
Load Combination		+D+0.750L+0.750S		Load Combination		+D+0.750L+0.750S	
Location of maximum on span	=	11.321	ft	Location of maximum on span	=	20.153	ft
Span # where maximum occurs	=	Span # 1		Span # where maximum occurs	=	Span # 1	
Maximum Deflection							
Max Downward Transient Deflection		0.193	in	Ratio =		1367	>=360
Max Upward Transient Deflection		0.000	in	Ratio =		0	<360
Max Downward Total Deflection		0.640	in	Ratio =		412	>=300
Max Upward Total Deflection		0.000	in	Ratio =		0	<300

Maximum Forces & Stresses for Load Combinations

Load Combination	Segment Length	Span #	Max Stress Ratios								Moment Values			Shear Values					
			M	V	C _d	C _{FV}	C _i	C _r	C _m	C _t	C _L	M	fb	F'b	V	fv	F'v		
D Only	Length = 22.0 ft	1	0.397	0.225	0.90	0.928	1.00	1.00	1.00	1.00	1.00	1.00	36.91	954.41	2405.73	0.00	0.00	0.00	0.00
+D+L	Length = 22.0 ft	1	0.442	0.271	1.00	0.928	1.00	1.00	1.00	1.00	1.00	1.00	45.73	1,182.40	2673.04	0.00	7.10	86.06	318.00
+D+Lr	Length = 22.0 ft	1	0.286	0.162	1.25	0.928	1.00	1.00	1.00	1.00	1.00	1.00	36.91	954.41	3341.30	0.00	0.00	0.00	0.00
+D+S	Length = 22.0 ft	1				0.928	1.00	1.00	1.00	1.00	1.00	1.00			0.00	0.00	0.00	0.00	0.00

Project Title:
 Engineer:
 Project ID:
 Project Descr:

Wood Beam

File = P:\CYJ7GB-PI2DNY94-NI2020I2S8Q79-7\Design\Gravity\Overstrength.ec6 .
 Software copyright ENERCALC, INC. 1983-2018, Build:10.18.12.13 .

Lic. # : KW-06004787

Licensee : MULHERN & KULP STRUCTURAL ENGINEERING INC

Description : B28 - Flush Beam at Garage

Load Combination Segment Length	Span #	Max Stress Ratios									Moment Values			Shear Values		
		M	V	C _d	C _{FN}	C _i	C _r	C _m	C _t	C _L	M	fb	F'b	V	fv	F'v
Length = 22.0 ft	1	0.484	0.287	1.15	0.928	1.00	1.00	1.00	1.00	1.00	57.54	1,487.92	3073.99	8.65	104.89	365.70
+D+0.750Lr+0.750L					0.928	1.00	1.00	1.00	1.00	1.00			0.00	0.00	0.00	0.00
Length = 22.0 ft	1	0.336	0.203	1.25	0.928	1.00	1.00	1.00	1.00	1.00	43.46	1,123.86	3341.30	6.65	80.62	397.50
+D+0.750L+0.750S					0.928	1.00	1.00	1.00	1.00	1.00			0.00	0.00	0.00	0.00
Length = 22.0 ft	1	0.497	0.304	1.15	0.928	1.00	1.00	1.00	1.00	1.00	59.08	1,527.66	3073.99	9.16	111.06	365.70
+D+0.60W					0.928	1.00	1.00	1.00	1.00	1.00			0.00	0.00	0.00	0.00
Length = 22.0 ft	1	0.223	0.126	1.60	0.928	1.00	1.00	1.00	1.00	1.00	36.91	954.41	4276.86	5.31	64.30	508.80
+1.126D+0.70E					0.928	1.00	1.00	1.00	1.00	1.00			0.00	0.00	0.00	0.00
Length = 22.0 ft	1	0.342	0.173	1.60	0.928	1.00	1.00	1.00	1.00	1.00	56.52	1,461.52	4276.86	7.28	88.20	508.80
+1.126D-0.70E					0.928	1.00	1.00	1.00	1.00	1.00			0.00	0.00	0.00	0.00
Length = 22.0 ft	1	0.167	0.111	1.60	0.928	1.00	1.00	1.00	1.00	1.00	27.70	716.28	4276.86	4.67	56.61	508.80
+D+0.750Lr+0.750L+0.450W					0.928	1.00	1.00	1.00	1.00	1.00			0.00	0.00	0.00	0.00
Length = 22.0 ft	1	0.263	0.158	1.60	0.928	1.00	1.00	1.00	1.00	1.00	43.46	1,123.86	4276.86	6.65	80.62	508.80
+D+0.750L+0.750S+0.450W					0.928	1.00	1.00	1.00	1.00	1.00			0.00	0.00	0.00	0.00
Length = 22.0 ft	1	0.357	0.218	1.60	0.928	1.00	1.00	1.00	1.00	1.00	59.08	1,527.66	4276.86	9.16	111.06	508.80
+1.090D+0.750L+0.750S+0.5250E					0.928	1.00	1.00	1.00	1.00	1.00			0.00	0.00	0.00	0.00
Length = 22.0 ft	1	0.443	0.253	1.60	0.928	1.00	1.00	1.00	1.00	1.00	73.27	1,894.68	4276.86	10.62	128.69	508.80
+1.090D+0.750L+0.750S-0.5250E					0.928	1.00	1.00	1.00	1.00	1.00			0.00	0.00	0.00	0.00
Length = 22.0 ft	1	0.317	0.206	1.60	0.928	1.00	1.00	1.00	1.00	1.00	52.35	1,353.64	4276.86	8.66	105.00	508.80
+0.60D+0.60W					0.928	1.00	1.00	1.00	1.00	1.00			0.00	0.00	0.00	0.00
Length = 22.0 ft	1	0.134	0.076	1.60	0.928	1.00	1.00	1.00	1.00	1.00	22.15	572.65	4276.86	3.18	38.58	508.80
+0.470D+0.70E					0.928	1.00	1.00	1.00	1.00	1.00			0.00	0.00	0.00	0.00
Length = 22.0 ft	1	0.195	0.090	1.60	0.928	1.00	1.00	1.00	1.00	1.00	32.31	835.42	4276.86	3.80	46.02	508.80
+0.470D-0.70E					0.928	1.00	1.00	1.00	1.00	1.00			0.00	0.00	0.00	0.00
Length = 22.0 ft	1	0.033	0.030	1.60	0.928	1.00	1.00	1.00	1.00	1.00	5.44	140.59	4276.86	1.24	15.04	508.80

Overall Maximum Deflections

Load Combination	Span	Max. "-" Defl	Location in Span	Load Combination	Max. "+" Defl	Location in Span
+1.090D+0.750L+0.750S+0.5250E	1	0.6401	11.241		0.0000	0.000

Vertical Reactions

Support notation : Far left is #1

Values in KIPS

Load Combination	Support 1	Support 2
Overall MAXimum	9.302	12.625
Overall MINimum	2.039	1.861
D Only	4.654	6.296
+D+L	5.465	8.590
+D+Lr	4.654	6.296
+D+S	8.054	10.383
+D+0.750Lr+0.750L	5.262	8.016
+D+0.750L+0.750S	7.813	11.082
+D+0.60W	4.654	6.296
+1.126D+0.70E	6.667	8.393
+D+0.750Lr+0.750L+0.450W	5.262	8.016
+D+0.750L+0.750S+0.450W	7.813	11.082
+1.090D+0.750L+0.750S+0.5250E	9.302	12.625
+0.60D+0.60W	2.792	3.778
+0.470D+0.70E	3.614	4.262
D Only	4.654	6.296
Lr Only		
L Only	0.812	2.293
S Only	3.401	4.087
W Only		
E Only	2.039	1.861
H Only		

Project Title:
 Engineer:
 Project ID:
 Project Descr:

Wood Beam

File = P:\CYJ7GB-PI2DNY94-NI2020I2S8Q79-7\Design\Gravity\Overstrength.ec6 .
 Software copyright ENERCALC, INC. 1983-2018, Build:10.18.12.13 .

Lic. # : KW-06004787

Licensee : MULHERN & KULP STRUCTURAL ENGINEERING INC

Description : B38 - Cant Flush Bm at Great Room

CODE REFERENCES

Calculations per NDS 2015, IBC 2015, CBC 2016, ASCE 7-10

Load Combination Set : ASCE 7-10

Material Properties

Analysis Method : Allowable Stress Design
 Load Combination : ASCE 7-10

Fb + 2600 psi E : Modulus of Elasticity
 Fb - 2600 psi Ebend- xx 2000 ksi
 Fc - Prll 2510 psi Eminbend - xx 1016.535 ksi
 Fc - Perp 750 psi
 Fv 285 psi
 Ft 1555 psi Density 42.01 pcf

Wood Species : Trus Joist
 Wood Grade : MicroLam LVL 2.0 E

Beam Bracing : Beam is Fully Braced against lateral-torsional buckling

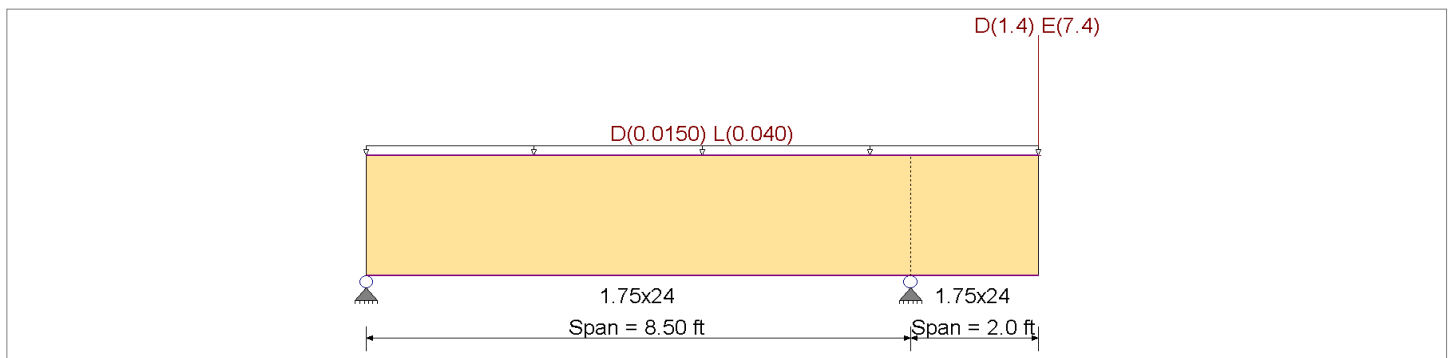

Applied Loads

Service loads entered. Load Factors will be applied for calculations.

Beam self weight calculated and added to loads

Loads on all spans...

Uniform Load on ALL spans : D = 0.0150, L = 0.040 k/ft

Load for Span Number 2

Point Load : D = 1.40, E = 7.40 k @ 2.0 ft

DESIGN SUMMARY

				Design OK			
Maximum Bending Stress Ratio	=	0.233	1	Maximum Shear Stress Ratio	=	0.534	1
Section used for this span		1.75x24		Section used for this span		1.75x24	
fb : Actual	=	969.58	psi	fv : Actual	=	243.49	psi
FB : Allowable	=	4,160.00	psi	Fv : Allowable	=	456.00	psi
Load Combination	=	+1.126D+0.70E		Load Combination	=	+1.126D+0.70E	
Location of maximum on span	=	8.500ft		Location of maximum on span	=	8.500ft	
Span # where maximum occurs	=	Span # 1		Span # where maximum occurs	=	Span # 1	
Maximum Deflection							
Max Downward Transient Deflection		0.044	in	Ratio =		1080	>=360
Max Upward Transient Deflection		-0.030	in	Ratio =		3444	>=360
Max Downward Total Deflection		0.040	in	Ratio =		1198	>=300
Max Upward Total Deflection		-0.026	in	Ratio =		3880	>=300

Maximum Forces & Stresses for Load Combinations

Load Combination	Segment Length	Span #	Max Stress Ratios								Moment Values			Shear Values				
			M	V	C _d	C _{FV}	C _i	C _r	C _m	C _t	C _L	M	fb	F'b	V	fv	F'v	
D Only																		
Length = 8.50 ft	1		0.087	0.203	0.90	1.000	1.00	1.00	1.00	1.00	1.00	2.85	203.89	2340.00	0.00	0.00	0.00	0.00
Length = 2.0 ft	2		0.087	0.203	0.90	1.000	1.00	1.00	1.00	1.00	1.00	2.85	203.89	2340.00	0.00	0.00	0.00	0.00
+D+L, LL Comb Run (*L)																		
Length = 8.50 ft	1		0.081	0.192	1.00	1.000	1.00	1.00	1.00	1.00	1.00	2.93	209.61	2600.00	0.00	0.00	0.00	0.00
Length = 2.0 ft	2		0.081	0.192	1.00	1.000	1.00	1.00	1.00	1.00	1.00	2.93	209.61	2600.00	0.00	0.00	0.00	0.00
+D+L, LL Comb Run (L*)																		
						1.000	1.00	1.00	1.00	1.00	1.00			0.00	0.00	0.00	0.00	0.00

Project Title:
 Engineer:
 Project ID:
 Project Descr:

Wood Beam

File = P:\CYJ7GB-PI2DNY94-NI2020I2S8Q79-7\Design\Gravity\Overstrength.ec6
 Software copyright ENERCALC, INC. 1983-2018, Build:10.18.12.13

Lic. #: KW-06004787

Licensee: MULHERN & KULP STRUCTURAL ENGINEERING INC

Description: B38 - Cant Flush Bm at Great Room

Load Combination	Segment Length	Span #	Max Stress Ratios								Moment Values			Shear Values			
			M	V	C _d	C _{FN}	C _i	C _r	C _m	C _t	C _L	M	fb	F'b	V	fv	F'v
	Length = 8.50 ft	1	0.078	0.182	1.00	1.000	1.00	1.00	1.00	1.00	1.00	2.85	203.89	2600.00	1.45	51.95	285.00
	Length = 2.0 ft	2	0.078	0.182	1.00	1.000	1.00	1.00	1.00	1.00	1.00	2.85	203.89	2600.00	1.45	51.95	285.00
+D+L, LL Comb Run (LL)						1.000	1.00	1.00	1.00	1.00	1.00			0.00	0.00	0.00	0.00
	Length = 8.50 ft	1	0.081	0.192	1.00	1.000	1.00	1.00	1.00	1.00	1.00	2.93	209.61	2600.00	1.53	54.80	285.00
	Length = 2.0 ft	2	0.081	0.192	1.00	1.000	1.00	1.00	1.00	1.00	1.00	2.93	209.61	2600.00	1.53	54.80	285.00
+D+Lr, LL Comb Run (*L)						1.000	1.00	1.00	1.00	1.00	1.00			0.00	0.00	0.00	0.00
	Length = 8.50 ft	1	0.063	0.146	1.25	1.000	1.00	1.00	1.00	1.00	1.00	2.85	203.89	3250.00	1.45	51.95	356.25
	Length = 2.0 ft	2	0.063	0.146	1.25	1.000	1.00	1.00	1.00	1.00	1.00	2.85	203.89	3250.00	1.45	51.95	356.25
+D+Lr, LL Comb Run (L*)						1.000	1.00	1.00	1.00	1.00	1.00			0.00	0.00	0.00	0.00
	Length = 8.50 ft	1	0.063	0.146	1.25	1.000	1.00	1.00	1.00	1.00	1.00	2.85	203.89	3250.00	1.45	51.95	356.25
	Length = 2.0 ft	2	0.063	0.146	1.25	1.000	1.00	1.00	1.00	1.00	1.00	2.85	203.89	3250.00	1.45	51.95	356.25
+D+Lr, LL Comb Run (LL)						1.000	1.00	1.00	1.00	1.00	1.00			0.00	0.00	0.00	0.00
	Length = 8.50 ft	1	0.063	0.146	1.25	1.000	1.00	1.00	1.00	1.00	1.00	2.85	203.89	3250.00	1.45	51.95	356.25
	Length = 2.0 ft	2	0.063	0.146	1.25	1.000	1.00	1.00	1.00	1.00	1.00	2.85	203.89	3250.00	1.45	51.95	356.25
+D+S						1.000	1.00	1.00	1.00	1.00	1.00			0.00	0.00	0.00	0.00
	Length = 8.50 ft	1	0.068	0.158	1.15	1.000	1.00	1.00	1.00	1.00	1.00	2.85	203.89	2990.00	1.45	51.95	327.75
	Length = 2.0 ft	2	0.068	0.158	1.15	1.000	1.00	1.00	1.00	1.00	1.00	2.85	203.89	2990.00	1.45	51.95	327.75
+D+0.750Lr+0.750L, LL Comb Run						1.000	1.00	1.00	1.00	1.00	1.00			0.00	0.00	0.00	0.00
	Length = 8.50 ft	1	0.064	0.152	1.25	1.000	1.00	1.00	1.00	1.00	1.00	2.91	208.18	3250.00	1.51	54.09	356.25
	Length = 2.0 ft	2	0.064	0.152	1.25	1.000	1.00	1.00	1.00	1.00	1.00	2.91	208.18	3250.00	1.51	54.09	356.25
+D+0.750Lr+0.750L, LL Comb Run						1.000	1.00	1.00	1.00	1.00	1.00			0.00	0.00	0.00	0.00
	Length = 8.50 ft	1	0.063	0.146	1.25	1.000	1.00	1.00	1.00	1.00	1.00	2.85	203.89	3250.00	1.45	51.95	356.25
	Length = 2.0 ft	2	0.063	0.146	1.25	1.000	1.00	1.00	1.00	1.00	1.00	2.85	203.89	3250.00	1.45	51.95	356.25
+D+0.750Lr+0.750L, LL Comb Run						1.000	1.00	1.00	1.00	1.00	1.00			0.00	0.00	0.00	0.00
	Length = 8.50 ft	1	0.064	0.152	1.25	1.000	1.00	1.00	1.00	1.00	1.00	2.91	208.18	3250.00	1.51	54.09	356.25
	Length = 2.0 ft	2	0.064	0.152	1.25	1.000	1.00	1.00	1.00	1.00	1.00	2.91	208.18	3250.00	1.51	54.09	356.25
+D+0.750L+0.750S, LL Comb Run (1.000	1.00	1.00	1.00	1.00	1.00			0.00	0.00	0.00	0.00
	Length = 8.50 ft	1	0.070	0.165	1.15	1.000	1.00	1.00	1.00	1.00	1.00	2.91	208.18	2990.00	1.51	54.09	327.75
	Length = 2.0 ft	2	0.070	0.165	1.15	1.000	1.00	1.00	1.00	1.00	1.00	2.91	208.18	2990.00	1.51	54.09	327.75
+D+0.750L+0.750S, LL Comb Run (1.000	1.00	1.00	1.00	1.00	1.00			0.00	0.00	0.00	0.00
	Length = 8.50 ft	1	0.068	0.158	1.15	1.000	1.00	1.00	1.00	1.00	1.00	2.85	203.89	2990.00	1.45	51.95	327.75
	Length = 2.0 ft	2	0.068	0.158	1.15	1.000	1.00	1.00	1.00	1.00	1.00	2.85	203.89	2990.00	1.45	51.95	327.75
+D+0.750L+0.750S, LL Comb Run (1.000	1.00	1.00	1.00	1.00	1.00			0.00	0.00	0.00	0.00
	Length = 8.50 ft	1	0.070	0.165	1.15	1.000	1.00	1.00	1.00	1.00	1.00	2.91	208.18	2990.00	1.51	54.09	327.75
	Length = 2.0 ft	2	0.070	0.165	1.15	1.000	1.00	1.00	1.00	1.00	1.00	2.91	208.18	2990.00	1.51	54.09	327.75
+D+0.60W						1.000	1.00	1.00	1.00	1.00	1.00			0.00	0.00	0.00	0.00
	Length = 8.50 ft	1	0.049	0.114	1.60	1.000	1.00	1.00	1.00	1.00	1.00	2.85	203.89	4160.00	1.45	51.95	456.00
	Length = 2.0 ft	2	0.049	0.114	1.60	1.000	1.00	1.00	1.00	1.00	1.00	2.85	203.89	4160.00	1.45	51.95	456.00
+1.126D+0.70E						1.000	1.00	1.00	1.00	1.00	1.00			0.00	0.00	0.00	0.00
	Length = 8.50 ft	1	0.233	0.534	1.60	1.000	1.00	1.00	1.00	1.00	1.00	13.57	969.58	4160.00	6.82	243.49	456.00
	Length = 2.0 ft	2	0.233	0.534	1.60	1.000	1.00	1.00	1.00	1.00	1.00	13.57	969.58	4160.00	6.82	243.49	456.00
+1.126D-0.70E						1.000	1.00	1.00	1.00	1.00	1.00			0.00	0.00	0.00	0.00
	Length = 8.50 ft	1	0.123	0.277	1.60	1.000	1.00	1.00	1.00	1.00	1.00	7.15	510.42	4160.00	3.54	126.51	456.00
	Length = 2.0 ft	2	0.123	0.282	1.60	1.000	1.00	1.00	1.00	1.00	1.00	7.15	510.42	4160.00	3.60	128.69	456.00
+D+0.750Lr+0.750L+0.450W, LL Cc						1.000	1.00	1.00	1.00	1.00	1.00			0.00	0.00	0.00	0.00
	Length = 8.50 ft	1	0.050	0.119	1.60	1.000	1.00	1.00	1.00	1.00	1.00	2.91	208.18	4160.00	1.51	54.09	456.00
	Length = 2.0 ft	2	0.050	0.119	1.60	1.000	1.00	1.00	1.00	1.00	1.00	2.91	208.18	4160.00	1.51	54.09	456.00
+D+0.750Lr+0.750L+0.450W, LL Cc						1.000	1.00	1.00	1.00	1.00	1.00			0.00	0.00	0.00	0.00
	Length = 8.50 ft	1	0.049	0.114	1.60	1.000	1.00	1.00	1.00	1.00	1.00	2.85	203.89	4160.00	1.45	51.95	456.00
	Length = 2.0 ft	2	0.049	0.114	1.60	1.000	1.00	1.00	1.00	1.00	1.00	2.85	203.89	4160.00	1.45	51.95	456.00
+D+0.750Lr+0.750L+0.450W, LL Cc						1.000	1.00	1.00	1.00	1.00	1.00			0.00	0.00	0.00	0.00
	Length = 8.50 ft	1	0.050	0.119	1.60	1.000	1.00	1.00	1.00	1.00	1.00	2.91	208.18	4160.00	1.51	54.09	456.00
	Length = 2.0 ft	2	0.050	0.119	1.60	1.000	1.00	1.00	1.00	1.00	1.00	2.91	208.18	4160.00	1.51	54.09	456.00
+D+0.750L+0.750S+0.450W, LL Co						1.000	1.00	1.00	1.00	1.00	1.00			0.00	0.00	0.00	0.00
	Length = 8.50 ft	1	0.050	0.119	1.60	1.000	1.00	1.00	1.00	1.00	1.00	2.91	208.18	4160.00	1.51	54.09	456.00
	Length = 2.0 ft	2	0.050	0.119	1.60	1.000	1.00	1.00	1.00	1.00	1.00	2.91	208.18	4160.00	1.51	54.09	456.00
+D+0.750L+0.750S+0.450W, LL Co						1.000	1.00	1.00	1.00	1.00	1.00			0.00	0.00	0.00	0.00
	Length = 8.50 ft	1	0.049	0.114	1.60	1.000	1.00	1.00	1.00	1.00	1.00	2.85	203.89	4160.00	1.45	51.95	456.00
	Length = 2.0 ft	2	0.049	0.114	1.60	1.000	1.00	1.00	1.00	1.00	1.00	2.85	203.89	4160.00	1.45	51.95	456.00
+D+0.750L+0.750S+0.450W, LL Co						1.000	1.00	1.00	1.00	1.00	1.00			0.00	0.00	0.00	0.00

Project Title:
 Engineer:
 Project ID:
 Project Descr:

Wood Beam

File = P:\CYJ7GB-PI2DNY94-NI2020I2S8Q79-7\Design\Gravity\Overstrength.ec6
 Software copyright ENERCALC, INC. 1983-2018, Build:10.18.12.13

Lic. #: KW-06004787

Licensee: MULHERN & KULP STRUCTURAL ENGINEERING INC

Description: B38 - Cant Flush Bm at Great Room

Load Combination	Segment Length	Span #	Max Stress Ratios								Moment Values			Shear Values			
			M	V	C _d	C _{FN}	C _i	C _r	C _m	C _t	C _L	M	fb	F'b	V	fv	F'v
	Length = 8.50 ft	1	0.050	0.119	1.60	1.000	1.00	1.00	1.00	1.00	1.00	2.91	208.18	4160.00	1.51	54.09	456.00
	Length = 2.0 ft	2	0.050	0.119	1.60	1.000	1.00	1.00	1.00	1.00	2.91	208.18	4160.00	1.51	54.09	456.00	
+1.090D+0.750L+0.750S+0.5250E,						1.000	1.00	1.00	1.00	1.00	1.00			0.00	0.00	0.00	0.00
	Length = 8.50 ft	1	0.188	0.433	1.60	1.000	1.00	1.00	1.00	1.00	10.94	781.53	4160.00	5.53	197.51	456.00	
	Length = 2.0 ft	2	0.188	0.433	1.60	1.000	1.00	1.00	1.00	1.00	10.94	781.53	4160.00	5.53	197.51	456.00	
+1.090D+0.750L+0.750S+0.5250E,						1.000	1.00	1.00	1.00	1.00	1.00			0.00	0.00	0.00	
	Length = 8.50 ft	1	0.187	0.428	1.60	1.000	1.00	1.00	1.00	1.00	10.88	777.24	4160.00	5.47	195.37	456.00	
	Length = 2.0 ft	2	0.187	0.428	1.60	1.000	1.00	1.00	1.00	1.00	10.88	777.24	4160.00	5.47	195.37	456.00	
+1.090D+0.750L+0.750S+0.5250E,						1.000	1.00	1.00	1.00	1.00	1.00			0.00	0.00	0.00	
	Length = 8.50 ft	1	0.188	0.433	1.60	1.000	1.00	1.00	1.00	1.00	10.94	781.53	4160.00	5.53	197.51	456.00	
	Length = 2.0 ft	2	0.188	0.433	1.60	1.000	1.00	1.00	1.00	1.00	10.94	781.53	4160.00	5.53	197.51	456.00	
+1.090D+0.750L+0.750S-0.5250E,						1.000	1.00	1.00	1.00	1.00	1.00			0.00	0.00	0.00	
	Length = 8.50 ft	1	0.079	0.175	1.60	1.000	1.00	1.00	1.00	1.00	4.60	328.47	4160.00	2.24	79.99	456.00	
	Length = 2.0 ft	2	0.079	0.185	1.60	1.000	1.00	1.00	1.00	1.00	4.60	328.47	4160.00	2.36	84.23	456.00	
+1.090D+0.750L+0.750S-0.5250E,						1.000	1.00	1.00	1.00	1.00	1.00			0.00	0.00	0.00	
	Length = 8.50 ft	1	0.080	0.180	1.60	1.000	1.00	1.00	1.00	1.00	4.66	332.76	4160.00	2.30	82.13	456.00	
	Length = 2.0 ft	2	0.080	0.185	1.60	1.000	1.00	1.00	1.00	1.00	4.66	332.76	4160.00	2.36	84.24	456.00	
+1.090D+0.750L+0.750S-0.5250E,						1.000	1.00	1.00	1.00	1.00	1.00			0.00	0.00	0.00	
	Length = 8.50 ft	1	0.079	0.175	1.60	1.000	1.00	1.00	1.00	1.00	4.60	328.47	4160.00	2.24	79.99	456.00	
	Length = 2.0 ft	2	0.079	0.185	1.60	1.000	1.00	1.00	1.00	1.00	4.60	328.47	4160.00	2.36	84.23	456.00	
+0.60D+0.60W						1.000	1.00	1.00	1.00	1.00	1.00			0.00	0.00	0.00	
	Length = 8.50 ft	1	0.029	0.068	1.60	1.000	1.00	1.00	1.00	1.00	1.71	122.34	4160.00	0.87	31.17	456.00	
	Length = 2.0 ft	2	0.029	0.068	1.60	1.000	1.00	1.00	1.00	1.00	1.71	122.34	4160.00	0.87	31.17	456.00	
+0.470D+0.70E						1.000	1.00	1.00	1.00	1.00	1.00			0.00	0.00	0.00	
	Length = 8.50 ft	1	0.201	0.459	1.60	1.000	1.00	1.00	1.00	1.00	11.70	835.83	4160.00	5.86	209.41	456.00	
	Length = 2.0 ft	2	0.201	0.459	1.60	1.000	1.00	1.00	1.00	1.00	11.70	835.83	4160.00	5.86	209.41	456.00	
+0.470D-0.70E						1.000	1.00	1.00	1.00	1.00	1.00			0.00	0.00	0.00	
	Length = 8.50 ft	1	0.155	0.352	1.60	1.000	1.00	1.00	1.00	1.00	9.02	644.17	4160.00	4.50	160.59	456.00	
	Length = 2.0 ft	2	0.155	0.354	1.60	1.000	1.00	1.00	1.00	1.00	9.02	644.17	4160.00	4.52	161.49	456.00	

Overall Maximum Deflections

Load Combination	Span	Max. "-" Defl	Location in Span	Load Combination	Max. "+" Defl	Location in Span
	1	0.0000	0.000	E Only	-0.0296	4.939
E Only	2	0.0444	2.000		0.0000	4.939

Vertical Reactions

Support notation : Far left is #1

Values in KIPS

Load Combination	Support 1	Support 2	Support 3
Overall MAXimum	-1.741	9.141	
Overall MINimum	-0.220	9.141	
D Only	-0.220	1.906	
+D+L, LL Comb Run (*L)	-0.229	1.996	
+D+L, LL Comb Run (L*)	-0.050	2.076	
+D+L, LL Comb Run (LL)	-0.059	2.166	
+D+Lr, LL Comb Run (*L)	-0.220	1.906	
+D+Lr, LL Comb Run (L*)	-0.220	1.906	
+D+Lr, LL Comb Run (LL)	-0.220	1.906	
+D+S	-0.220	1.906	
+D+0.750Lr+0.750L, LL Comb Run (*L)	-0.227	1.973	
+D+0.750Lr+0.750L, LL Comb Run (L*)	-0.092	2.034	
+D+0.750Lr+0.750L, LL Comb Run (LL)	-0.100	2.101	
+D+0.750L+0.750S, LL Comb Run (*L)	-0.227	1.973	
+D+0.750L+0.750S, LL Comb Run (L*)	-0.092	2.034	
+D+0.750L+0.750S, LL Comb Run (LL)	-0.100	2.101	
+D+0.60W	-0.220	1.906	
+1.126D+0.70E	-1.467	8.545	
+D+0.750Lr+0.750L+0.450W, LL Comb R	-0.227	1.973	
+D+0.750Lr+0.750L+0.450W, LL Comb R	-0.092	2.034	
+D+0.750Lr+0.750L+0.450W, LL Comb R	-0.100	2.101	
+D+0.750L+0.750S+0.450W, LL Comb Ru	-0.227	1.973	
+D+0.750L+0.750S+0.450W, LL Comb Ru	-0.092	2.034	

Project Title:
 Engineer:
 Project ID:
 Project Descr:

Wood Beam

File = P:\CYJ7GB-PI2DNY94-NI2020I2S8Q79-7\Design\Gravity\Overstrength.ec6 .
 Software copyright ENERCALC, INC. 1983-2018, Build:10.18.12.13 .

Lic. # : KW-06004787

Licensee : MULHERN & KULP STRUCTURAL ENGINEERING INC

Description : B38 - Cant Flush Bm at Great Room

Vertical Reactions

Support notation : Far left is #1

Values in KIPS

Load Combination	Support 1	Support 2	Support 3
+D+0.750L+0.750S+0.450W, LL Comb Ru	-0.100	2.101	
+1.090D+0.750L+0.750S+0.5250E, LL C	-1.161	6.944	
+1.090D+0.750L+0.750S+0.5250E, LL C	-1.026	7.004	
+1.090D+0.750L+0.750S+0.5250E, LL C	-1.033	7.071	
+0.60D+0.60W	-0.132	1.144	
+0.470D+0.70E	-1.322	7.295	
D Only	-0.220	1.906	
Lr Only, LL Comb Run (*L)			
Lr Only, LL Comb Run (L*)			
Lr Only, LL Comb Run (LL)			
L Only, LL Comb Run (*L)	-0.009	0.089	
L Only, LL Comb Run (L*)	0.170	0.170	
L Only, LL Comb Run (LL)	0.161	0.259	
S Only			
W Only			
E Only	-1.741	9.141	
H Only			

Project Title:
 Engineer:
 Project ID:
 Project Descr:

Wood Beam

File = P:\CYJ7GB-PI2DNY94-NI2020I2S8Q79-7\Design\Gravity\Overstrength.ec6 .
 Software copyright ENERCALC, INC. 1983-2018, Build:10.18.12.13 .

Lic. #: KW-06004787

Licensee: MULHERN & KULP STRUCTURAL ENGINEERING INC

Description: B39 - Cant Flush Bm at Great Room

CODE REFERENCES

Calculations per NDS 2015, IBC 2015, CBC 2016, ASCE 7-10

Load Combination Set: ASCE 7-10

Material Properties

Analysis Method: Allowable Stress Design
 Load Combination: ASCE 7-10

Fb + 2600 psi E : Modulus of Elasticity
 Fb - 2600 psi Ebend- xx 2000 ksi
 Fc - Prll 2510 psi Eminbend - xx 1016.535 ksi
 Fc - Perp 750 psi
 Fv 285 psi
 Ft 1555 psi Density 42.01 pcf

Wood Species: Trus Joist
 Wood Grade: MicroLam LVL 2.0 E

Beam Bracing: Beam is Fully Braced against lateral-torsional buckling

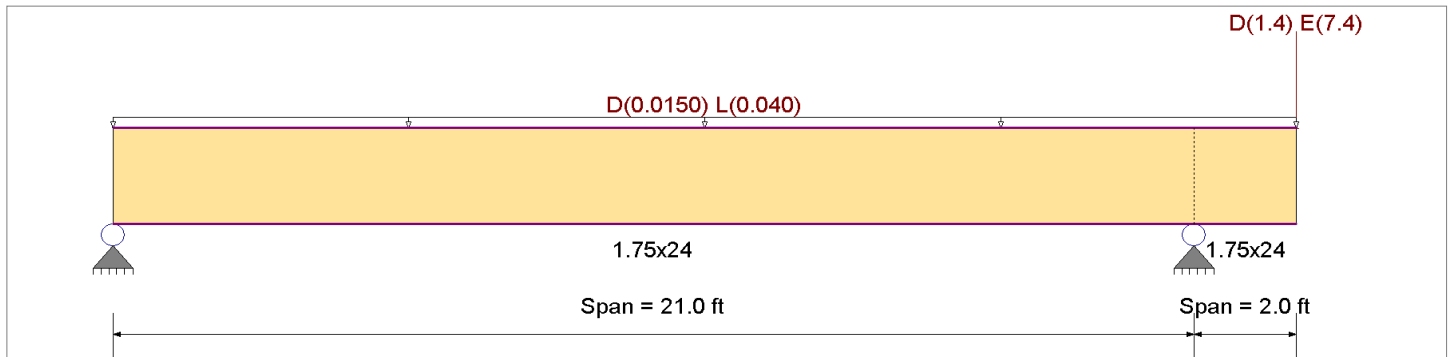

Applied Loads

Service loads entered. Load Factors will be applied for calculations.

Beam self weight calculated and added to loads

Loads on all spans...

Uniform Load on ALL spans: D = 0.0150, L = 0.040 k/ft

Load for Span Number 2

Point Load: D = 1.40, E = 7.40 k @ 2.0 ft

DESIGN SUMMARY

Design OK

Maximum Bending Stress Ratio	=	0.233	1	Maximum Shear Stress Ratio	=	0.534	1
Section used for this span		1.75x24		Section used for this span		1.75x24	
fb : Actual	=	969.58	psi	fv : Actual	=	243.49	psi
FB : Allowable	=	4,160.00	psi	Fv : Allowable	=	456.00	psi
Load Combination		+1.126D+0.70E		Load Combination		+1.126D+0.70E	
Location of maximum on span	=	21.000	ft	Location of maximum on span	=	21.000	ft
Span # where maximum occurs	=	Span # 1		Span # where maximum occurs	=	Span # 1	
Maximum Deflection							
Max Downward Transient Deflection		0.097	in	Ratio =		492	>=360
Max Upward Transient Deflection		-0.181	in	Ratio =		1394	>=360
Max Downward Total Deflection		0.079	in	Ratio =		606	>=300
Max Upward Total Deflection		-0.133	in	Ratio =		1889	>=300

Maximum Forces & Stresses for Load Combinations

Load Combination	Segment Length	Span #	Max Stress Ratios								Moment Values			Shear Values				
			M	V	C _d	C _{FV}	C _i	C _r	C _m	C _t	C _L	M	fb	F'b	V	fv	F'v	
D Only																		
Length = 21.0 ft	1		0.087	0.203	0.90	1.000	1.00	1.00	1.00	1.00	1.00	2.85	203.89	2340.00	1.45	51.95	256.50	
Length = 2.0 ft	2		0.087	0.203	0.90	1.000	1.00	1.00	1.00	1.00	1.00	2.85	203.89	2340.00	1.45	51.95	256.50	
+D+L, LL Comb Run (*L)																		
Length = 21.0 ft	1		0.081	0.192	1.00	1.000	1.00	1.00	1.00	1.00	1.00	2.93	209.61	2600.00	1.53	54.80	285.00	
Length = 2.0 ft	2		0.081	0.192	1.00	1.000	1.00	1.00	1.00	1.00	1.00	2.93	209.61	2600.00	1.53	54.80	285.00	
+D+L, LL Comb Run (L*)																		
						1.000	1.00	1.00	1.00	1.00	1.00			0.00	0.00	0.00	0.00	

Project Title:
 Engineer:
 Project ID:
 Project Descr:

Wood Beam

File = P:\CYJ7GB-PI2DNY94-NI2020I2S8Q79-7\Design\Gravity\Overstrength.ec6
 Software copyright ENERCALC, INC. 1983-2018, Build:10.18.12.13

Lic. # : KW-06004787

Licensee : MULHERN & KULP STRUCTURAL ENGINEERING INC

Description : B39 - Cant Flush Bm at Great Room

Load Combination	Segment Length	Span #	Max Stress Ratios								Moment Values			Shear Values				
			M	V	C _d	C _{FN}	C _i	C _r	C _m	C _t	C _L	M	f _b	F' _b	V	f _v	F' _v	
	Length = 21.0 ft	1	0.078	0.182	1.00	1.000	1.00	1.00	1.00	1.00	1.00	1.00	2.85	203.89	2600.00	1.45	51.95	285.00
	Length = 2.0 ft	2	0.078	0.182	1.00	1.000	1.00	1.00	1.00	1.00	1.00	1.00	2.85	203.89	2600.00	1.45	51.95	285.00
+D+L, LL Comb Run (LL)						1.000	1.00	1.00	1.00	1.00	1.00	1.00			0.00	0.00	0.00	0.00
	Length = 21.0 ft	1	0.081	0.192	1.00	1.000	1.00	1.00	1.00	1.00	1.00	1.00	2.93	209.61	2600.00	1.53	54.80	285.00
	Length = 2.0 ft	2	0.081	0.192	1.00	1.000	1.00	1.00	1.00	1.00	1.00	1.00	2.93	209.61	2600.00	1.53	54.80	285.00
+D+Lr, LL Comb Run (*L)						1.000	1.00	1.00	1.00	1.00	1.00	1.00			0.00	0.00	0.00	0.00
	Length = 21.0 ft	1	0.063	0.146	1.25	1.000	1.00	1.00	1.00	1.00	1.00	1.00	2.85	203.89	3250.00	1.45	51.95	356.25
	Length = 2.0 ft	2	0.063	0.146	1.25	1.000	1.00	1.00	1.00	1.00	1.00	1.00	2.85	203.89	3250.00	1.45	51.95	356.25
+D+Lr, LL Comb Run (L*)						1.000	1.00	1.00	1.00	1.00	1.00	1.00			0.00	0.00	0.00	0.00
	Length = 21.0 ft	1	0.063	0.146	1.25	1.000	1.00	1.00	1.00	1.00	1.00	1.00	2.85	203.89	3250.00	1.45	51.95	356.25
	Length = 2.0 ft	2	0.063	0.146	1.25	1.000	1.00	1.00	1.00	1.00	1.00	1.00	2.85	203.89	3250.00	1.45	51.95	356.25
+D+Lr, LL Comb Run (LL)						1.000	1.00	1.00	1.00	1.00	1.00	1.00			0.00	0.00	0.00	0.00
	Length = 21.0 ft	1	0.063	0.146	1.25	1.000	1.00	1.00	1.00	1.00	1.00	1.00	2.85	203.89	3250.00	1.45	51.95	356.25
	Length = 2.0 ft	2	0.063	0.146	1.25	1.000	1.00	1.00	1.00	1.00	1.00	1.00	2.85	203.89	3250.00	1.45	51.95	356.25
+D+S						1.000	1.00	1.00	1.00	1.00	1.00	1.00			0.00	0.00	0.00	0.00
	Length = 21.0 ft	1	0.068	0.158	1.15	1.000	1.00	1.00	1.00	1.00	1.00	1.00	2.85	203.89	2990.00	1.45	51.95	327.75
	Length = 2.0 ft	2	0.068	0.158	1.15	1.000	1.00	1.00	1.00	1.00	1.00	1.00	2.85	203.89	2990.00	1.45	51.95	327.75
+D+0.750Lr+0.750L, LL Comb Run						1.000	1.00	1.00	1.00	1.00	1.00	1.00			0.00	0.00	0.00	0.00
	Length = 21.0 ft	1	0.064	0.152	1.25	1.000	1.00	1.00	1.00	1.00	1.00	1.00	2.91	208.18	3250.00	1.51	54.09	356.25
	Length = 2.0 ft	2	0.064	0.152	1.25	1.000	1.00	1.00	1.00	1.00	1.00	1.00	2.91	208.18	3250.00	1.51	54.09	356.25
+D+0.750Lr+0.750L, LL Comb Run						1.000	1.00	1.00	1.00	1.00	1.00	1.00			0.00	0.00	0.00	0.00
	Length = 21.0 ft	1	0.063	0.146	1.25	1.000	1.00	1.00	1.00	1.00	1.00	1.00	2.85	203.89	3250.00	1.45	51.95	356.25
	Length = 2.0 ft	2	0.063	0.146	1.25	1.000	1.00	1.00	1.00	1.00	1.00	1.00	2.85	203.89	3250.00	1.45	51.95	356.25
+D+0.750Lr+0.750L, LL Comb Run						1.000	1.00	1.00	1.00	1.00	1.00	1.00			0.00	0.00	0.00	0.00
	Length = 21.0 ft	1	0.064	0.152	1.25	1.000	1.00	1.00	1.00	1.00	1.00	1.00	2.91	208.18	3250.00	1.51	54.09	356.25
	Length = 2.0 ft	2	0.064	0.152	1.25	1.000	1.00	1.00	1.00	1.00	1.00	1.00	2.91	208.18	3250.00	1.51	54.09	356.25
+D+0.750L+0.750S, LL Comb Run (1.000	1.00	1.00	1.00	1.00	1.00	1.00			0.00	0.00	0.00	0.00
	Length = 21.0 ft	1	0.070	0.165	1.15	1.000	1.00	1.00	1.00	1.00	1.00	1.00	2.91	208.18	2990.00	1.51	54.09	327.75
	Length = 2.0 ft	2	0.070	0.165	1.15	1.000	1.00	1.00	1.00	1.00	1.00	1.00	2.91	208.18	2990.00	1.51	54.09	327.75
+D+0.750L+0.750S, LL Comb Run (1.000	1.00	1.00	1.00	1.00	1.00	1.00			0.00	0.00	0.00	0.00
	Length = 21.0 ft	1	0.068	0.158	1.15	1.000	1.00	1.00	1.00	1.00	1.00	1.00	2.85	203.89	2990.00	1.45	51.95	327.75
	Length = 2.0 ft	2	0.068	0.158	1.15	1.000	1.00	1.00	1.00	1.00	1.00	1.00	2.85	203.89	2990.00	1.45	51.95	327.75
+D+0.750L+0.750S, LL Comb Run (1.000	1.00	1.00	1.00	1.00	1.00	1.00			0.00	0.00	0.00	0.00
	Length = 21.0 ft	1	0.070	0.165	1.15	1.000	1.00	1.00	1.00	1.00	1.00	1.00	2.91	208.18	2990.00	1.51	54.09	327.75
	Length = 2.0 ft	2	0.070	0.165	1.15	1.000	1.00	1.00	1.00	1.00	1.00	1.00	2.91	208.18	2990.00	1.51	54.09	327.75
+D+0.60W						1.000	1.00	1.00	1.00	1.00	1.00	1.00			0.00	0.00	0.00	0.00
	Length = 21.0 ft	1	0.049	0.114	1.60	1.000	1.00	1.00	1.00	1.00	1.00	1.00	2.85	203.89	4160.00	1.45	51.95	456.00
	Length = 2.0 ft	2	0.049	0.114	1.60	1.000	1.00	1.00	1.00	1.00	1.00	1.00	2.85	203.89	4160.00	1.45	51.95	456.00
+1.126D+0.70E						1.000	1.00	1.00	1.00	1.00	1.00	1.00			0.00	0.00	0.00	0.00
	Length = 21.0 ft	1	0.233	0.534	1.60	1.000	1.00	1.00	1.00	1.00	1.00	1.00	13.57	969.58	4160.00	6.82	243.49	456.00
	Length = 2.0 ft	2	0.233	0.534	1.60	1.000	1.00	1.00	1.00	1.00	1.00	1.00	13.57	969.58	4160.00	6.82	243.49	456.00
+1.126D-0.70E						1.000	1.00	1.00	1.00	1.00	1.00	1.00			0.00	0.00	0.00	0.00
	Length = 21.0 ft	1	0.123	0.277	1.60	1.000	1.00	1.00	1.00	1.00	1.00	1.00	7.15	510.42	4160.00	3.54	126.51	456.00
	Length = 2.0 ft	2	0.123	0.282	1.60	1.000	1.00	1.00	1.00	1.00	1.00	1.00	7.15	510.42	4160.00	3.60	128.69	456.00
+D+0.750Lr+0.750L+0.450W, LL Cc						1.000	1.00	1.00	1.00	1.00	1.00	1.00			0.00	0.00	0.00	0.00
	Length = 21.0 ft	1	0.050	0.119	1.60	1.000	1.00	1.00	1.00	1.00	1.00	1.00	2.91	208.18	4160.00	1.51	54.09	456.00
	Length = 2.0 ft	2	0.050	0.119	1.60	1.000	1.00	1.00	1.00	1.00	1.00	1.00	2.91	208.18	4160.00	1.51	54.09	456.00
+D+0.750Lr+0.750L+0.450W, LL Cc						1.000	1.00	1.00	1.00	1.00	1.00	1.00			0.00	0.00	0.00	0.00
	Length = 21.0 ft	1	0.049	0.114	1.60	1.000	1.00	1.00	1.00	1.00	1.00	1.00	2.85	203.89	4160.00	1.45	51.95	456.00
	Length = 2.0 ft	2	0.049	0.114	1.60	1.000	1.00	1.00	1.00	1.00	1.00	1.00	2.85	203.89	4160.00	1.45	51.95	456.00
+D+0.750Lr+0.750L+0.450W, LL Cc						1.000	1.00	1.00	1.00	1.00	1.00	1.00			0.00	0.00	0.00	0.00
	Length = 21.0 ft	1	0.050	0.119	1.60	1.000	1.00	1.00	1.00	1.00	1.00	1.00	2.91	208.18	4160.00	1.51	54.09	456.00
	Length = 2.0 ft	2	0.050	0.119	1.60	1.000	1.00	1.00	1.00	1.00	1.00	1.00	2.91	208.18	4160.00	1.51	54.09	456.00
+D+0.750L+0.750S+0.450W, LL Co						1.000	1.00	1.00	1.00	1.00	1.00	1.00			0.00	0.00	0.00	0.00
	Length = 21.0 ft	1	0.050	0.119	1.60	1.000	1.00	1.00	1.00	1.00	1.00	1.00	2.91	208.18	4160.00	1.51	54.09	456.00
	Length = 2.0 ft	2	0.050	0.119	1.60	1.000	1.00	1.00	1.00	1.00	1.00	1.00	2.91	208.18	4160.00	1.51	54.09	456.00
+D+0.750L+0.750S+0.450W, LL Co						1.000	1.00	1.00	1.00	1.00	1.00	1.00			0.00	0.00	0.00	0.00
	Length = 21.0 ft	1	0.049	0.114	1.60	1.000	1.00	1.00	1.00	1.00	1.00	1.00	2.85	203.89	4160.00	1.45	51.95	456.00
	Length = 2.0 ft	2	0.049	0.114	1.60	1.000	1.00	1.00	1.00	1.00	1.00	1.00	2.85	203.89	4160.00	1.45	51.95	456.00
+D+0.750L+0.750S+0.450W, LL Co						1.000	1.00	1.00	1.00	1.00	1.00	1.00			0.00	0.00	0.00	0.00

Project Title:
 Engineer:
 Project ID:
 Project Descr:

Wood Beam

File = P:\CYJ7GB-PI2DNY94-NI2020\2S8Q79-7\Design\Gravity\Overstrength.ec6
 Software copyright ENERCALC, INC. 1983-2018, Build:10.18.12.13

Lic. #: KW-06004787

Licensee: MULHERN & KULP STRUCTURAL ENGINEERING INC

Description: B39 - Cant Flush Bm at Great Room

Load Combination	Segment Length	Span #	Max Stress Ratios								Moment Values			Shear Values			
			M	V	C _d	C _{FN}	C _i	C _r	C _m	C _t	C _L	M	fb	F'b	V	fv	F'v
	Length = 21.0 ft	1	0.050	0.119	1.60	1.000	1.00	1.00	1.00	1.00	1.00	2.91	208.18	4160.00	1.51	54.09	456.00
	Length = 2.0 ft	2	0.050	0.119	1.60	1.000	1.00	1.00	1.00	1.00	1.00	2.91	208.18	4160.00	1.51	54.09	456.00
+1.090D+0.750L+0.750S+0.5250E,						1.000	1.00	1.00	1.00	1.00	1.00			0.00	0.00	0.00	0.00
	Length = 21.0 ft	1	0.188	0.433	1.60	1.000	1.00	1.00	1.00	1.00	1.00	10.94	781.53	4160.00	5.53	197.51	456.00
	Length = 2.0 ft	2	0.188	0.433	1.60	1.000	1.00	1.00	1.00	1.00	1.00	10.94	781.53	4160.00	5.53	197.51	456.00
+1.090D+0.750L+0.750S+0.5250E,						1.000	1.00	1.00	1.00	1.00	1.00			0.00	0.00	0.00	0.00
	Length = 21.0 ft	1	0.187	0.428	1.60	1.000	1.00	1.00	1.00	1.00	1.00	10.88	777.24	4160.00	5.47	195.37	456.00
	Length = 2.0 ft	2	0.187	0.428	1.60	1.000	1.00	1.00	1.00	1.00	1.00	10.88	777.24	4160.00	5.47	195.37	456.00
+1.090D+0.750L+0.750S+0.5250E,						1.000	1.00	1.00	1.00	1.00	1.00			0.00	0.00	0.00	0.00
	Length = 21.0 ft	1	0.188	0.433	1.60	1.000	1.00	1.00	1.00	1.00	1.00	10.94	781.53	4160.00	5.53	197.51	456.00
	Length = 2.0 ft	2	0.188	0.433	1.60	1.000	1.00	1.00	1.00	1.00	1.00	10.94	781.53	4160.00	5.53	197.51	456.00
+1.090D+0.750L+0.750S-0.5250E,						1.000	1.00	1.00	1.00	1.00	1.00			0.00	0.00	0.00	0.00
	Length = 21.0 ft	1	0.081	0.175	1.60	1.000	1.00	1.00	1.00	1.00	1.00	4.74	338.85	4160.00	2.24	79.99	456.00
	Length = 2.0 ft	2	0.079	0.185	1.60	1.000	1.00	1.00	1.00	1.00	1.00	4.60	328.47	4160.00	2.36	84.23	456.00
+1.090D+0.750L+0.750S-0.5250E,						1.000	1.00	1.00	1.00	1.00	1.00			0.00	0.00	0.00	0.00
	Length = 21.0 ft	1	0.104	0.180	1.60	1.000	1.00	1.00	1.00	1.00	1.00	6.03	430.91	4160.00	2.30	82.13	456.00
	Length = 2.0 ft	2	0.080	0.185	1.60	1.000	1.00	1.00	1.00	1.00	1.00	4.66	332.76	4160.00	2.36	84.24	456.00
+1.090D+0.750L+0.750S-0.5250E,						1.000	1.00	1.00	1.00	1.00	1.00			0.00	0.00	0.00	0.00
	Length = 21.0 ft	1	0.103	0.175	1.60	1.000	1.00	1.00	1.00	1.00	1.00	5.99	428.01	4160.00	2.24	79.99	456.00
	Length = 2.0 ft	2	0.079	0.185	1.60	1.000	1.00	1.00	1.00	1.00	1.00	4.60	328.47	4160.00	2.36	84.23	456.00
+0.60D+0.60W						1.000	1.00	1.00	1.00	1.00	1.00			0.00	0.00	0.00	0.00
	Length = 21.0 ft	1	0.029	0.068	1.60	1.000	1.00	1.00	1.00	1.00	1.00	1.71	122.34	4160.00	0.87	31.17	456.00
	Length = 2.0 ft	2	0.029	0.068	1.60	1.000	1.00	1.00	1.00	1.00	1.00	1.71	122.34	4160.00	0.87	31.17	456.00
+0.470D+0.70E						1.000	1.00	1.00	1.00	1.00	1.00			0.00	0.00	0.00	0.00
	Length = 21.0 ft	1	0.201	0.459	1.60	1.000	1.00	1.00	1.00	1.00	1.00	11.70	835.83	4160.00	5.86	209.41	456.00
	Length = 2.0 ft	2	0.201	0.459	1.60	1.000	1.00	1.00	1.00	1.00	1.00	11.70	835.83	4160.00	5.86	209.41	456.00
+0.470D-0.70E						1.000	1.00	1.00	1.00	1.00	1.00			0.00	0.00	0.00	0.00
	Length = 21.0 ft	1	0.155	0.352	1.60	1.000	1.00	1.00	1.00	1.00	1.00	9.02	644.17	4160.00	4.50	160.59	456.00
	Length = 2.0 ft	2	0.155	0.354	1.60	1.000	1.00	1.00	1.00	1.00	1.00	9.02	644.17	4160.00	4.52	161.49	456.00

Overall Maximum Deflections

Load Combination	Span	Max. "-" Defl	Location in Span	Load Combination	Max. "+" Defl	Location in Span
	1	0.0000	0.000	E Only	-0.1807	12.201
E Only	2	0.0972	2.000		0.0000	12.201

Vertical Reactions

Support notation : Far left is #1

Values in KIPS

Load Combination	Support 1	Support 2	Support 3
Overall MAXimum	-0.705	8.105	
Overall MINimum	0.416	8.105	
D Only	0.150	1.877	
+D+L, LL Comb Run (*L)	0.146	1.960	
+D+L, LL Comb Run (L*)	0.570	2.297	
+D+L, LL Comb Run (LL)	0.566	2.380	
+D+Lr, LL Comb Run (*L)	0.150	1.877	
+D+Lr, LL Comb Run (L*)	0.150	1.877	
+D+Lr, LL Comb Run (LL)	0.150	1.877	
+D+S	0.150	1.877	
+D+0.750Lr+0.750L, LL Comb Run (*L)	0.147	1.939	
+D+0.750Lr+0.750L, LL Comb Run (L*)	0.465	2.192	
+D+0.750Lr+0.750L, LL Comb Run (LL)	0.462	2.254	
+D+0.750L+0.750S, LL Comb Run (*L)	0.147	1.939	
+D+0.750L+0.750S, LL Comb Run (L*)	0.465	2.192	
+D+0.750L+0.750S, LL Comb Run (LL)	0.462	2.254	
+D+0.60W	0.150	1.877	
+1.126D+0.70E	-0.324	7.786	
+D+0.750Lr+0.750L+0.450W, LL Comb R	0.147	1.939	
+D+0.750Lr+0.750L+0.450W, LL Comb R	0.465	2.192	
+D+0.750Lr+0.750L+0.450W, LL Comb R	0.462	2.254	
+D+0.750L+0.750S+0.450W, LL Comb Ru	0.147	1.939	
+D+0.750L+0.750S+0.450W, LL Comb Ru	0.465	2.192	

Project Title:
 Engineer:
 Project ID:
 Project Descr:

Wood Beam

File = P:\CYJ7GB-PI2DNY94-NI2020I2S8Q79-7\Design\Gravity\Overstrength.ec6 .
 Software copyright ENERCALC, INC. 1983-2018, Build:10.18.12.13 .

Lic. # : KW-06004787

Licensee : MULHERN & KULP STRUCTURAL ENGINEERING INC

Description : B39 - Cant Flush Bm at Great Room

Vertical Reactions

Support notation : Far left is #1

Values in KIPS

Load Combination	Support 1	Support 2	Support 3
+D+0.750L+0.750S+0.450W, LL Comb Ru	0.462	2.254	
+1.090D+0.750L+0.750S+0.5250E, LL C	-0.209	6.363	
+1.090D+0.750L+0.750S+0.5250E, LL C	0.109	6.615	
+1.090D+0.750L+0.750S+0.5250E, LL C	0.106	6.678	
+0.60D+0.60W	0.090	1.126	
+0.470D+0.70E	-0.423	6.555	
D Only	0.150	1.877	
Lr Only, LL Comb Run (*L)			
Lr Only, LL Comb Run (L*)			
Lr Only, LL Comb Run (LL)			
L Only, LL Comb Run (*L)	-0.004	0.084	
L Only, LL Comb Run (L*)	0.420	0.420	
L Only, LL Comb Run (LL)	0.416	0.504	
S Only			
W Only			
E Only	-0.705	8.105	
H Only			

WOOD POST EVALUATION

(ANALYSIS PER THE NDS)
 POST @ GARAGE
 (1)3 1/2 x 5 1/2 POST, 11.5 FT PLATE HEIGHT, VERSALAM 1800 GRADE

DESIGN TYPE		<input type="radio"/> Bearing Wall	<input checked="" type="radio"/> Post w/ in Wall	<input type="radio"/> Freestanding Post
MEMBER BRACING		<input checked="" type="checkbox"/> Weak Axis Braced	Method (Ext Face/Int. Face):	<input type="checkbox"/> Strong Axis Braced
		<input checked="" type="checkbox"/> Blocked Panel Edges	OSB/GWB	
LOADING		STABILITY FACTOR CALCULATION (C_p)		
AXIAL LOADS	DL (LBS)	6700	C	0.90
	LL (LBS)	810	D (IN)	5.50
	LLR (LBS)	0	F _C E (PSI)	1302
	SL (LBS)	3400	F _C * (PSI)	4800
	ALL. WIND PRESSURE (PSF)	18	F _C E/F _C *	0.27
CONSTRUCTION		ADJUSTMENT FACTORS		
LUMBER SPECIES	VERSALAM	C _D	1.60	
LUMBER GRADE	1800	C _F (F _B)	1.00	
SIZE	3 1/2 x 5 1/2	C _F (F _{OLL})	1.00	
PLATE HEIGHT (FT)	11.5	C _R	1.00	
TRIBUTARY WIDTH (IN)	72	C _P	0.262	
STUD PLYS	1	C _V	1.09	
KE	1.00			
WALL FINISH MATERIAL	FLEXIBLE			
MATERIAL PROPERTIES		ALLOWABLE STRESSES		
F _B (PSI)	2750	F _B ^I (PSI)	4798	
F _C (PSI)	3000	F _C ^I (PSI)	1257	
E (PSI)	1800000			
E _{MIN} (PSI)	933143			
SECTION PROPERTIES		DESIGN FORCES & STRESSES		
THICKNESS (IN)	3.50	CONTROLLING LOAD COMBINATION: DL+ 0.75(LL+SL+LLR+W)		
DEPTH (IN)	5.50	P (LBS)	9858	
LENGTH, L _e (FT)	11.13	M (LB-IN)	15038	
A (IN ²)	19.25	F _C (PSI)	512	
S _x (IN ³)	17.65	F _B (PSI)	852	
I _x (IN ⁴)	48.53	Δ (IN)	0.30	
CONSTR. LOAD ONLY	NO	L/Δ RATIO	448	
SLENDERNESS (L _e /D)	24.3			

COMBINED INTERACTION RESULTS

STRESS INTERACTION = 0.46 < 1.00

(1)3 1/2 x 5 1/2 POST, 11.5 FT PLATE HEIGHT, VERSALAM 1800 GRADE IS ADEQUATE

WOOD BEARING WALL EVALUATION

(ANALYSIS PER THE NDS)
 BF WALL AT STAIRS
 (1)2X6 AT 16 O.C. STUD WALL, 12.67 FT PLATE HEIGHT, HF STUD GRADE

DESIGN TYPE		<input checked="" type="radio"/> Bearing Wall <input type="radio"/> Post w/ in Wall <input type="radio"/> Freestanding Post		
MEMBER BRACING		<input checked="" type="checkbox"/> Weak Axis Braced <input checked="" type="checkbox"/> Blocked Panel Edges	Method (Ext Face/Int. Face): <div style="border: 1px solid black; padding: 2px; display: inline-block;">OSB/GWB</div> <input type="checkbox"/> Strong Axis Braced	
LOADING		STABILITY FACTOR CALCULATION (C_p)		
AXIAL LOADS	DL (PLF)	60	C	0.80
	LL (PLF)	0	D (IN)	5.50
	LLR (PLF)	0	F_{CE} (PSI)	503
	SL (PLF)	150	F_{C^*} (PSI)	1280
ALL. WIND PRESSURE (PSF)		19.9	F_{CE}/F_{C^*}	0.39
CONSTRUCTION		ADJUSTMENT FACTORS		
LUMBER SPECIES	HF	C_D	1.60	
LUMBER GRADE	STUD	$C_F (F_B)$	1.00	
SIZE	2X6	$C_F (F_{OLL})$	1.00	
PLATE HEIGHT (FT)	12.67	C_R	1.35	
STUD SPACING (IN)	16	C_P	0.354	
STUD PLYS	1	C_V	N/A	
KE	1.00			
WALL FINISH MATERIAL	FLEXIBLE			
MATERIAL PROPERTIES		ALLOWABLE STRESSES		
F_B (PSI)	675	F_B^I (PSI)	1458	
$F_{C }$ (PSI)	800	F_C^I (PSI)	453	
E (PSI)	1200000			
E_{MIN} (PSI)	440000			
SECTION PROPERTIES		DESIGN FORCES & STRESSES		
THICKNESS (IN)	1.50	CONTROLLING LOAD COMBINATION	DL+W	
DEPTH (IN)	5.50	P (LBS)	80	
LENGTH, L_e (FT)	12.30	M (LB-IN)	6016	
A (IN ²)	8.25	F_C (PSI)	10	
S_x (IN ³)	7.56	F_B (PSI)	796	
I_x (IN ⁴)	20.80	Δ (IN)	0.28	
CONSTR. LOAD ONLY	NO	L/Δ RATIO	521	
SLENDERNESS (L_e/D)	26.8			

COMBINED INTERACTION RESULTS

STRESS INTERACTION = 0.56 < 1.00

(1)2X6 AT 16 O.C. STUD WALL, 12.67 FT PLATE HEIGHT, HF STUD GRADE IS ADEQUATE

KING STUD EVALUATION

- 17.9 PSF WIND PRESSURE
- EXP. C, $K_{zt} = 1.0$
- FIND MAX ALLOWABLE OPENING FOR (1) 2x6, (2) 2x6 + (3) 2x6 KING.
- HF 'STUD' GRADE
- WEAK AXIS BRACED

C 2nd FLR:

- WORST CASE PLATE HT. = 10' $H = 120'' - 4.5'' = 115.5'' = 9.625'$

BENDING:

$$F'_b = f_b \times C_u \times C_L \times C_F$$

$$= 675 \text{ psi} \times 1.6$$

$$F'_b = 1080 \text{ psi}$$

$$M_{ALL} = 1080 \text{ psi} \times 7.56 \text{ in}^3$$

$$\stackrel{152x6}{=} = 8164.8 \text{ in}^3$$

$$= 0.68''$$

STRESS EQ.

$$f_b = \frac{M}{S} \rightarrow \frac{w l^2}{8} = 1080 \text{ psi} \times \overset{\# \text{ OF KINGS}}{(1)} (7.56)$$

$$\frac{w (9.625)^2}{8} = 0.68''$$

$$w = 0.0587 \text{ kip} \rightarrow 58.7 \text{ PLF}$$

$$w = 17.9 + \left(\frac{1}{2} \text{ OPENING}\right) = 58.7 \text{ PLF}$$

$$\left(\frac{1}{2} \text{ OPENING}\right) = 3.28' = 39.35''$$

$$\text{MAX OPENING} = 6.56'$$

\therefore (1) 2x6 KING OK @ 6'-6" MAX OPENING.

KING	MAX OPENING
(1) 2x6	6'-6"
(2) 2x6	13'-1"
(3) 2x6	19'-8"

PROJECT NAME

SHEET

DRAWN BY

PROJECT NUMBER



Use menu item Settings > Printing & Title Block to set these five lines of information for your program.

Project Name/Number : fnd walls

Title 10' Basement Wall

Dsgnr: NJD

Description....

DTL 1+2

Page : 1
Date: 21 DEC 2020

This Wall in File: P:\Client Files\244 - McCullough Architects\2020\20019 - Barcelo Homes - Lot 1 -

RetainPro (c) 1987-2019, Build 11.20.03.31

License : KW-06059959

License To : MULHERN & KULP STRUCTURAL ENGINEERING INC

Cantilevered Retaining Wall

Code: IBC 2015,ACI 318-14,ACI 530-13

Criteria

Retained Height = 10.00 ft
Wall height above soil = 0.67 ft
Slope Behind Wall = 0.00
Height of Soil over Toe = 0.00 in
Water height over heel = 0.0 ft

Soil Data

Allow Soil Bearing = 2,000.0 psf
Equivalent Fluid Pressure Method
Active Heel Pressure = 30.0 psf/ft

Passive Pressure = 250.0 psf/ft
Soil Density, Heel = 110.0 pcf
Soil Density, Toe = 0.00 pcf
Footing|Soil Friction = 0.400
Soil height to ignore for passive pressure = 12.00 in

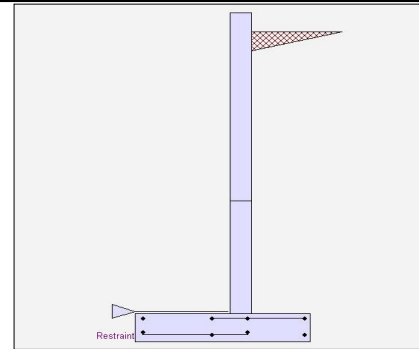

Surcharge Loads

Surcharge Over Heel = 0.0 psf
Used To Resist Sliding & Overturning
Surcharge Over Toe = 0.0 psf
Used for Sliding & Overturning

Lateral Load Applied to Stem

Lateral Load = 0.0 #/ft
...Height to Top = 0.00 ft
...Height to Bottom = 0.00 ft
Load Type = Wind (W)
(Service Level)
Wind on Exposed Stem = 0.0 psf
(Service Level)

Adjacent Footing Load

Adjacent Footing Load = 0.0 lbs
Footing Width = 0.00 ft
Eccentricity = 0.00 in
Wall to Ftg CL Dist = 0.00 ft
Footing Type = Line Load
Base Above/Below Soil at Back of Wall = 0.0 ft
Poisson's Ratio = 0.300

Axial Load Applied to Stem

Axial Dead Load = 100.0 lbs
Axial Live Load = 0.0 lbs
Axial Load Eccentricity = 0.0 in

Earth Pressure Seismic Load

Method : Uniform
Multiplier Used = 7.270
(Multiplier used on soil density)
Uniform Seismic Force = 79.970
Total Seismic Force = 879.670

Design Summary

Wall Stability Ratios

Overturning = 1.53 OK
Slab Resists All Sliding !

Total Bearing Load = 4,009 lbs
...resultant ecc. = 16.95 in

Soil Pressure @ Toe = 1,999 psf OK
Soil Pressure @ Heel = 0 psf OK
Allowable = 2,000 psf
Soil Pressure Less Than Allowable

ACI Factored @ Toe = 2,798 psf
ACI Factored @ Heel = 0 psf

Footing Shear @ Toe = 40.9 psi OK
Footing Shear @ Heel = 23.8 psi OK
Allowable = 75.0 psi

Sliding Calcs

Lateral Sliding Force = 2,430.8 lbs

Stem Construction

	2nd	Bottom
Design Height Above Ftg	ft = 4.00	Stem OK 0.00
Wall Material Above "Ht"	= Concrete	Concrete
Design Method	= LRFD	LRFD
Thickness	= 8.00	8.00
Rebar Size	= # 5	# 5
Rebar Spacing	= 16.00	8.00
Rebar Placed at	= 6.5 in	6.5 in

Design Data

fb/FB + fa/Fa = 0.482 0.948

Total Force @ Section

Service Level lbs =
Strength Level lbs = 1,343.8 3,199.7

Moment....Actual

Service Level ft-# =
Strength Level ft-# = 3,167.5 11,998.5

Moment.....Allowable ft-# = 6,561.4 12,644.5

Shear.....Actual

Service Level psi =
Strength Level psi = 17.2 41.0

Shear.....Allowable psi = 82.2 82.2

Anet (Masonry) in2 =

Rebar Depth 'd' in = 6.50 6.50

Masonry Data

f'm psi =
Fs psi =

Solid Grouting =

Modular Ratio 'n' =

Wall Weight psf = 100.0 100.0

Short Term Factor =

Equiv. Solid Thick. =

Masonry Block Type = Medium Weight

Masonry Design Method = ASD

Concrete Data

f'c psi = 3,000.0 3,000.0

Fy psi = 60,000.0 60,000.0

Vertical component of active lateral soil pressure IS NOT considered in the calculation of soil bearing

Load Factors

Building Code IBC 2015,ACI
Dead Load 1.200
Live Load 1.600
Earth, H 1.600
Wind, W 1.000
Seismic, E 1.000

Use menu item Settings > Printing & Title Block
to set these five lines of information
for your program.

Project Name/Number : fnd walls

Title 10' Basement Wall

Dsgnr: NJD

Description....

DTL 1+2

Page : 2
Date: 21 DEC 2020

This Wall in File: P:\Client Files\244 - McCullough Architects\2020\20019 - Barcelo Homes - Lot 1 -

RetainPro (c) 1987-2019, Build 11.20.03.31

License : KW-06059959

License To : MULHERN & KULP STRUCTURAL ENGINEERING INC

Cantilevered Retaining Wall

Code: IBC 2015,ACI 318-14,ACI 530-13

Concrete Stem Rebar Area Details

2nd Stem	Vertical Reinforcing	Horizontal Reinforcing	
As (based on applied moment) :	0.1139 in ² /ft		
(4/3) * As :	0.1518 in ² /ft	Min Stem T&S Reinf Area 1.281 in ²	
200bd/fy : 200(12)(6.5)/60000 :	0.26 in ² /ft	Min Stem T&S Reinf Area per ft of stem Height : 0.192 in ² /ft	
0.0018bh : 0.0018(12)(8) :	0.1728 in ² /ft	Horizontal Reinforcing Options :	
	=====	One layer of : Two layers of :	
Required Area :	0.1728 in ² /ft	#4@ 12.50 in	#4@ 25.00 in
Provided Area :	0.2325 in ² /ft	#5@ 19.38 in	#5@ 38.75 in
Maximum Area :	1.0567 in ² /ft	#6@ 27.50 in	#6@ 55.00 in

Bottom Stem	Vertical Reinforcing	Horizontal Reinforcing	
As (based on applied moment) :	0.4314 in ² /ft		
(4/3) * As :	0.5751 in ² /ft	Min Stem T&S Reinf Area 0.768 in ²	
200bd/fy : 200(12)(6.5)/60000 :	0.26 in ² /ft	Min Stem T&S Reinf Area per ft of stem Height : 0.192 in ² /ft	
0.0018bh : 0.0018(12)(8) :	0.1728 in ² /ft	Horizontal Reinforcing Options :	
	=====	One layer of : Two layers of :	
Required Area :	0.4314 in ² /ft	#4@ 12.50 in	#4@ 25.00 in
Provided Area :	0.465 in ² /ft	#5@ 19.38 in	#5@ 38.75 in
Maximum Area :	1.0567 in ² /ft	#6@ 27.50 in	#6@ 55.00 in

Footing Data

Toe Width	=	3.00 ft
Heel Width	=	2.50
Total Footing Width	=	5.50
Footing Thickness	=	12.00 in
Key Width	=	0.00 in
Key Depth	=	0.00 in
Key Distance from Toe	=	0.00 ft
f'c =	2,500 psi	Fy = 60,000 psi
Footing Concrete Density	=	150.00 pcf
Min. As %	=	0.0018
Cover @ Top	2.00	@ Btm = 3.00 in

Footing Design Results

		Toe	Heel
Factored Pressure	=	2,798	0 psf
Mu' : Upward	=	113,431	5 ft-#
Mu' : Downward	=	9,720	2,521 ft-#
Mu: Design	=	8,643	2,516 ft-#
Actual 1-Way Shear	=	40.86	23.76 psi
Allow 1-Way Shear	=	75.00	75.00 psi
Toe Reinforcing	=	# 5 @ 12.00 in	
Heel Reinforcing	=	# 5 @ 12.00 in	
Key Reinforcing	=	None Spec'd	
Footing Torsion, Tu	=		0.00 ft-lbs
Footing Allow. Torsion, phi Tu	=		0.00 ft-lbs

If torsion exceeds allowable, provide supplemental design for footing torsion.

Other Acceptable Sizes & Spacings

Toe: #4@ 7.66 in, #5@ 11.88 in, #6@ 16.86 in, #7@ 23.00 in, #8@ 30.28 in, #9@ 38
Heel: #4@ 9.25 in, #5@ 14.35 in, #6@ 20.37 in, #7@ 27.77 in, #8@ 36.57 in, #9@ 46
Key: No key defined

Min footing T&S reinf Area	1.43	in ²
Min footing T&S reinf Area per foot	0.26	in ² /ft
If one layer of horizontal bars:		If two layers of horizontal bars:
#4@ 9.26 in		#4@ 18.52 in
#5@ 14.35 in		#5@ 28.70 in
#6@ 20.37 in		#6@ 40.74 in

Use menu item Settings > Printing & Title Block
to set these five lines of information
for your program.

Project Name/Number : fnd walls

Title 10' Basement Wall

Dsgnr: NJD

Description....

DTL 1+2

Page : 3
Date: 21 DEC 2020

This Wall in File: P:\Client Files\244 - McCullough Architects\2020\20019 - Barcelo Homes - Lot 1 -

RetainPro (c) 1987-2019, Build 11.20.03.31

License : KW-06059959

License To : MULHERN & KULP STRUCTURAL ENGINEERING INC

Cantilevered Retaining Wall

Code: IBC 2015,ACI 318-14,ACI 530-13

Summary of Overturning & Resisting Forces & Moments

ItemOVERTURNING.....			RESISTING.....		
	Force lbs	Distance ft	Moment ft-#		Force lbs	Distance ft	Moment ft-#
HL Act Pres (ab water tbl)	1,815.0	3.67	6,655.0	Soil Over HL (ab. water tbl)	2,016.7	4.58	9,243.1
HL Act Pres (be water tbl)				Soil Over HL (bel. water tbl)		4.58	9,243.1
Hydrostatic Force				Watre Table			
Buoyant Force =				Sloped Soil Over Heel =			
Surcharge over Heel =				Surcharge Over Heel =			
Surcharge Over Toe =				Adjacent Footing Load =			
Adjacent Footing Load =				Axial Dead Load on Stem =	100.0	3.33	333.3
Added Lateral Load =				* Axial Live Load on Stem =			
Load @ Stem Above Soil =				Soil Over Toe =			
Seismic Earth Load =	615.8	5.50	3,386.7	Surcharge Over Toe =			
				Stem Weight(s) =	1,067.0	3.33	3,556.7
				Earth @ Stem Transitions =			
Total	= 2,430.8	O.T.M. =	10,041.7	Footing Weight =	825.0	2.75	2,268.8
				Key Weight =			
				Vert. Component =			
Resisting/Overturning Ratio		=	1.53	Total =	4,008.7 lbs	R.M.=	15,401.8
Vertical Loads used for Soil Pressure =		4,008.7 lbs					

* Axial live load NOT included in total displayed, or used for overturning resistance, but is included for soil pressure calculation.

If seismic is included, the OTM and sliding ratios may be 1.1 per section 1807.2.3 of IBC.

Vertical component of active lateral soil pressure IS NOT considered in the calculation of Sliding Resistance.

Vertical component of active lateral soil pressure IS NOT considered in the calculation of Overturning Resistance.

Tilt

Horizontal Deflection at Top of Wall due to settlement of soil

(Deflection due to wall bending not considered)

Soil Spring Reaction Modulus 250.0 pci

Horizontal Defl @ Top of Wall (approximate only) 0.108 in

The above calculation is not valid if the heel soil bearing pressure exceeds that of the toe, because the wall would then tend to rotate into the retained soil.

Use menu item Settings > Printing & Title Block
to set these five lines of information
for your program.

Project Name/Number : fnd walls

Title 12' Basement Wall

Dsgnr: NJD

Description....

DTL 3

Page : 1
Date: 21 DEC 2020

This Wall in File: P:\Client Files\244 - McCullough Architects\2020\20019 - Barcelo Homes - Lot 1 -

RetainPro (c) 1987-2019, Build 11.20.03.31

License : KW-06059959

License To : MULHERN & KULP STRUCTURAL ENGINEERING INC

Cantilevered Retaining Wall

Code: IBC 2015,ACI 318-14,ACI 530-13

Criteria

Retained Height = 12.00 ft
Wall height above soil = 1.00 ft
Slope Behind Wall = 0.00
Height of Soil over Toe = 0.00 in
Water height over heel = 0.0 ft

Soil Data

Allow Soil Bearing = 2,000.0 psf
Equivalent Fluid Pressure Method
Active Heel Pressure = 30.0 psf/ft

Passive Pressure = 250.0 psf/ft
Soil Density, Heel = 110.0 pcf
Soil Density, Toe = 0.00 pcf
Footing||Soil Friction = 0.400
Soil height to ignore for passive pressure = 12.00 in

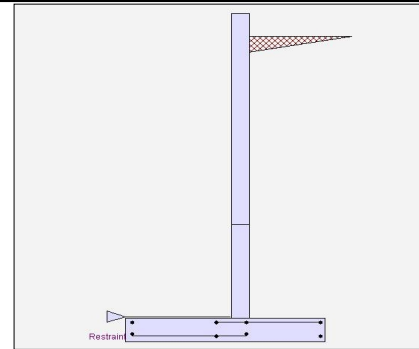

Surcharge Loads

Surcharge Over Heel = 0.0 psf
Used To Resist Sliding & Overturning
Surcharge Over Toe = 0.0 psf
Used for Sliding & Overturning

Lateral Load Applied to Stem

Lateral Load = 0.0 #/ft
...Height to Top = 0.00 ft
...Height to Bottom = 0.00 ft
Load Type = Wind (W)
(Service Level)
Wind on Exposed Stem = 0.0 psf
(Service Level)

Adjacent Footing Load

Adjacent Footing Load = 0.0 lbs
Footing Width = 0.00 ft
Eccentricity = 0.00 in
Wall to Ftg CL Dist = 0.00 ft
Footing Type = Line Load
Base Above/Below Soil at Back of Wall = 0.0 ft
Poisson's Ratio = 0.300

Axial Load Applied to Stem

Axial Dead Load = 100.0 lbs
Axial Live Load = 0.0 lbs
Axial Load Eccentricity = 0.0 in

Earth Pressure Seismic Load

Method : Uniform
Multiplier Used = 9.080
(Multiplier used on soil density)

Uniform Seismic Force = 118.040
Total Seismic Force = 1,534.520

Design Summary

Wall Stability Ratios

Overturning = 1.84 OK
Slab Resists All Sliding !

Total Bearing Load = 6,265 lbs
...resultant ecc. = 16.13 in

Soil Pressure @ Toe = 1,736 psf OK
Soil Pressure @ Heel = 0 psf OK
Allowable = 2,000 psf
Soil Pressure Less Than Allowable

ACI Factored @ Toe = 2,431 psf
ACI Factored @ Heel = 0 psf

Footing Shear @ Toe = 54.7 psi OK
Footing Shear @ Heel = 34.2 psi OK
Allowable = 75.0 psi

Sliding Calcs

Lateral Sliding Force = 3,609.2 lbs

Stem Construction

	2nd	Bottom
Design Height Above Ftg	ft = 4.00	Ratio > 1.0 0.00
Wall Material Above "Ht"	= Concrete	Concrete
Design Method	= LRFD	LRFD
Thickness	= 8.00	8.00
Rebar Size	= # 6	# 6
Rebar Spacing	= 12.00	6.00
Rebar Placed at	= 6.5 in	6.5 in

Design Data

fb/FB + fa/Fa = 0.655 1.000

Total Force @ Section

Service Level lbs =
Strength Level lbs = 2,480.3 4,872.5

Moment....Actual

Service Level ft-# =
Strength Level ft-# = 7,873.3 22,322.9
Moment.....Allowable ft-# = 12,013.3 22,313.3

Shear.....Actual

Service Level psi =
Strength Level psi = 31.8 62.5
Shear.....Allowable psi = 82.2 82.2

Anet (Masonry) in2 =
Rebar Depth 'd' in = 6.50 6.50

Masonry Data

f'm psi =
Fs psi =
Solid Grouting =
Modular Ratio 'n' =
Wall Weight psf = 100.0 100.0
Short Term Factor =
Equiv. Solid Thick. =
Masonry Block Type = Medium Weight
Masonry Design Method = ASD

Concrete Data

f'c psi = 3,000.0 3,000.0
Fy psi = 60,000.0 60,000.0

Vertical component of active lateral soil pressure IS NOT considered in the calculation of soil bearing

Load Factors

Building Code IBC 2015,ACI
Dead Load 1.200
Live Load 1.600
Earth, H 1.600
Wind, W 1.000
Seismic, E 1.000

Use menu item Settings > Printing & Title Block
to set these five lines of information
for your program.

Project Name/Number : fnd walls

Title 12' Basement Wall

Dsgnr: NJD

Description....

DTL 3

Page : 2
Date: 21 DEC 2020

This Wall in File: P:\Client Files\244 - McCullough Architects\2020\20019 - Barcelo Homes - Lot 1 -

RetainPro (c) 1987-2019, Build 11.20.03.31

License : KW-06059959

License To : MULHERN & KULP STRUCTURAL ENGINEERING INC

Cantilevered Retaining Wall

Code: IBC 2015,ACI 318-14,ACI 530-13

Concrete Stem Rebar Area Details

2nd Stem	Vertical Reinforcing	Horizontal Reinforcing	
As (based on applied moment) :	0.2831 in2/ft		
(4/3) * As :	0.3774 in2/ft	Min Stem T&S Reinf Area 1.728 in2	
200bd/fy : 200(12)(6.5)/60000 :	0.26 in2/ft	Min Stem T&S Reinf Area per ft of stem Height : 0.192 in2/ft	
0.0018bh : 0.0018(12)(8) :	0.1728 in2/ft	Horizontal Reinforcing Options :	
	=====	One layer of : Two layers of :	
Required Area :	0.2831 in2/ft	#4@ 12.50 in	#4@ 25.00 in
Provided Area :	0.44 in2/ft	#5@ 19.38 in	#5@ 38.75 in
Maximum Area :	1.0567 in2/ft	#6@ 27.50 in	#6@ 55.00 in

Bottom Stem	Vertical Reinforcing	Horizontal Reinforcing	
As (based on applied moment) :	0.8025 in2/ft		
(4/3) * As :	1.07 in2/ft	Min Stem T&S Reinf Area 0.768 in2	
200bd/fy : 200(12)(6.5)/60000 :	0.26 in2/ft	Min Stem T&S Reinf Area per ft of stem Height : 0.192 in2/ft	
0.0018bh : 0.0018(12)(8) :	0.1728 in2/ft	Horizontal Reinforcing Options :	
	=====	One layer of : Two layers of :	
Required Area :	0.8025 in2/ft	#4@ 12.50 in	#4@ 25.00 in
Provided Area :	0.88 in2/ft	#5@ 19.38 in	#5@ 38.75 in
Maximum Area :	1.0567 in2/ft	#6@ 27.50 in	#6@ 55.00 in

Footing Data

Toe Width	=	4.00 ft
Heel Width	=	3.50
Total Footing Width	=	7.50
Footing Thickness	=	12.00 in
Key Width	=	0.00 in
Key Depth	=	0.00 in
Key Distance from Toe	=	0.00 ft
f'c =	2,500 psi	Fy = 60,000 psi
Footing Concrete Density	=	150.00 pcf
Min. As %	=	0.0018
Cover @ Top	2.00	@ Btm = 3.00 in

Footing Design Results

		<u>Toe</u>	<u>Heel</u>
Factored Pressure	=	2,431	0 psf
Mu' : Upward	=	190,247	931 ft-#
Mu' : Downward	=	17,280	7,081 ft-#
Mu: Design	=	14,414	6,150 ft-#
Actual 1-Way Shear	=	54.75	34.24 psi
Allow 1-Way Shear	=	75.00	75.00 psi
Toe Reinforcing	=	# 5 @ 8.00 in	
Heel Reinforcing	=	# 5 @ 8.00 in	
Key Reinforcing	=	None Spec'd	
Footing Torsion, Tu	=		0.00 ft-lbs
Footing Allow. Torsion, phi Tu	=		0.00 ft-lbs

If torsion exceeds allowable, provide supplemental design for footing torsion.

Other Acceptable Sizes & Spacings

Toe: #4@ 6.13 in, #5@ 9.50 in, #6@ 13.48 in, #7@ 18.39 in, #8@ 24.21 in, #9@ 30.
Heel: #4@ 9.25 in, #5@ 14.35 in, #6@ 20.37 in, #7@ 27.77 in, #8@ 36.57 in, #9@ 46
Key: No key defined

Min footing T&S reinf Area	1.94	in2
Min footing T&S reinf Area per foot	0.26	in2 /ft
If one layer of horizontal bars:		If two layers of horizontal bars:
#4@ 9.26 in		#4@ 18.52 in
#5@ 14.35 in		#5@ 28.70 in
#6@ 20.37 in		#6@ 40.74 in

Use menu item Settings > Printing & Title Block
to set these five lines of information
for your program.

Project Name/Number : fnd walls

Title 12' Basement Wall

Dsgnr: NJD

Description....

DTL 3

Page : 3
Date: 21 DEC 2020

This Wall in File: P:\Client Files\244 - McCullough Architects\2020\20019 - Barcelo Homes - Lot 1 -

RetainPro (c) 1987-2019, Build 11.20.03.31

License : KW-06059959

License To : MULHERN & KULP STRUCTURAL ENGINEERING INC

Cantilevered Retaining Wall

Code: IBC 2015,ACI 318-14,ACI 530-13

Summary of Overturning & Resisting Forces & Moments

ItemOVERTURNING.....			RESISTING.....		
	Force lbs	Distance ft	Moment ft-#		Force lbs	Distance ft	Moment ft-#
HL Act Pres (ab water tbl)	2,535.0	4.33	10,985.0	Soil Over HL (ab. water tbl)	3,740.0	6.08	22,751.7
HL Act Pres (be water tbl)				Soil Over HL (bel. water tbl)		6.08	22,751.7
Hydrostatic Force				Watre Table			
Buoyant Force =				Sloped Soil Over Heel =			
Surcharge over Heel =				Surcharge Over Heel =			
Surcharge Over Toe =				Adjacent Footing Load =			
Adjacent Footing Load =				Axial Dead Load on Stem =	100.0	4.33	433.3
Added Lateral Load =				* Axial Live Load on Stem =			
Load @ Stem Above Soil =				Soil Over Toe =			
Seismic Earth Load =	1,074.2	6.50	6,982.1	Surcharge Over Toe =			
				Stem Weight(s) =	1,300.0	4.33	5,633.3
				Earth @ Stem Transitions =			
Total	3,609.2	O.T.M. =	17,967.1	Footing Weight =	1,125.0	3.75	4,218.8
				Key Weight =			
				Vert. Component =			
Resisting/Overturning Ratio		=	1.84	Total =	6,265.0 lbs	R.M.=	33,037.1
Vertical Loads used for Soil Pressure =		6,265.0 lbs					

* Axial live load NOT included in total displayed, or used for overturning resistance, but is included for soil pressure calculation.

If seismic is included, the OTM and sliding ratios may be 1.1 per section 1807.2.3 of IBC.

Vertical component of active lateral soil pressure IS NOT considered in the calculation of Sliding Resistance.

Vertical component of active lateral soil pressure IS NOT considered in the calculation of Overturning Resistance.

Tilt

Horizontal Deflection at Top of Wall due to settlement of soil

(Deflection due to wall bending not considered)

Soil Spring Reaction Modulus 250.0 pci

Horizontal Defl @ Top of Wall (approximate only) 0.084 in

The above calculation is not valid if the heel soil bearing pressure exceeds that of the toe, because the wall would then tend to rotate into the retained soil.

Use menu item Settings > Printing & Title Block
to set these five lines of information
for your program.

Project Name/Number : fnd walls

Title 12' Basement Wall

Dsgnr: NJD

Description....

DTL 6

Page : 1
Date: 21 DEC 2020

This Wall in File: P:\Client Files\244 - McCullough Architects\2020\20019 - Barcelo Homes - Lot 1 -

RetainPro (c) 1987-2019, Build 11.20.03.31

License : KW-06059959

License To : MULHERN & KULP STRUCTURAL ENGINEERING INC

Cantilevered Retaining Wall

Code: IBC 2015,ACI 318-14,ACI 530-13

Criteria

Retained Height	=	11.67 ft
Wall height above soil	=	0.33 ft
Slope Behind Wall	=	0.00
Height of Soil over Toe	=	0.00 in
Water height over heel	=	0.0 ft

Soil Data

Allow Soil Bearing	=	2,000.0 psf
Equivalent Fluid Pressure Method		
Active Heel Pressure	=	30.0 psf/ft
	=	
Passive Pressure	=	250.0 psf/ft
Soil Density, Heel	=	110.00 pcf
Soil Density, Toe	=	0.00 pcf
Footings Soil Friction	=	0.400
Soil height to ignore for passive pressure	=	12.00 in

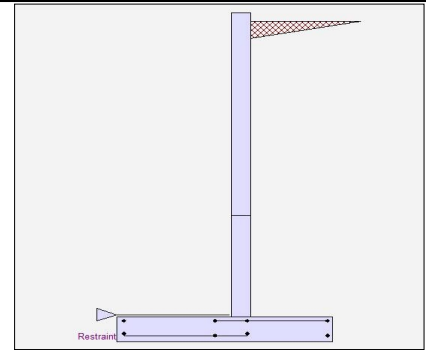

Surcharge Loads

Surcharge Over Heel	=	45.0 psf
Used To Resist Sliding & Overturning		
Surcharge Over Toe	=	0.0 psf
Used for Sliding & Overturning		

Lateral Load Applied to Stem

Lateral Load	=	0.0 #/ft
...Height to Top	=	0.00 ft
...Height to Bottom	=	0.00 ft
Load Type	=	Wind (W) (Service Level)
Wind on Exposed Stem	=	0.0 psf (Service Level)

Adjacent Footing Load

Adjacent Footing Load	=	0.0 lbs
Footing Width	=	0.00 ft
Eccentricity	=	0.00 in
Wall to Ftg CL Dist	=	0.00 ft
Footing Type		Line Load
Base Above/Below Soil at Back of Wall	=	0.0 ft
Poisson's Ratio	=	0.300

Axial Load Applied to Stem

Axial Dead Load	=	100.0 lbs
Axial Live Load	=	0.0 lbs
Axial Load Eccentricity	=	0.0 in

Earth Pressure Seismic Load

Method : Uniform		
Multiplier Used	=	9.080
(Multiplier used on soil density)		
Uniform Seismic Force	=	115.044
Total Seismic Force	=	1,457.602

Design Summary

Wall Stability Ratios

Overturning	=	1.86 OK
Slab Resists All Sliding !		

Total Bearing Load	=	6,190 lbs
...resultant ecc.	=	15.66 in

Soil Pressure @ Toe	=	1,688 psf OK
Soil Pressure @ Heel	=	0 psf OK
Allowable	=	2,000 psf
Soil Pressure Less Than Allowable		

ACI Factored @ Toe	=	2,363 psf
ACI Factored @ Heel	=	0 psf
Footing Shear @ Toe	=	53.3 psi OK
Footing Shear @ Heel	=	34.5 psi OK
Allowable	=	75.0 psi

Sliding Calcs

Lateral Sliding Force	=	3,583.8 lbs
-----------------------	---	-------------

Vertical component of active lateral soil pressure IS
NOT considered in the calculation of soil bearing

Load Factors

Building Code	IBC 2015,ACI
Dead Load	1.200
Live Load	1.600
Earth, H	1.600
Wind, W	1.000
Seismic, E	1.000

Stem Construction

	2nd	Bottom
Design Height Above Ftg	ft = 4.00	ft = 0.00
Wall Material Above "Ht"	Concrete	Concrete
Design Method	LRFD	LRFD
Thickness	= 8.00	= 8.00
Rebar Size	= # 6	= # 6
Rebar Spacing	= 12.00	= 6.00
Rebar Placed at	= 6.5 in	= 6.5 in

Design Data

fb/FB + fa/Fa	=	0.630	0.980
---------------	---	-------	-------

Total Force @ Section

Service Level	lbs =		
Strength Level	lbs =	2,444.9	4,840.2

Moment....Actual

Service Level	ft-# =		
Strength Level	ft-# =	7,571.3	21,885.6
Moment....Allowable	ft-# =	12,013.3	22,313.3

Shear.....Actual

Service Level	psi =		
Strength Level	psi =	31.3	62.1
Shear.....Allowable	psi =	82.2	82.2
Anet (Masonry)	in2 =		
Rebar Depth 'd'	in =	6.50	6.50

Masonry Data

f'm	psi =		
Fs	psi =		
Solid Grouting	=		
Modular Ratio 'n'	=		
Wall Weight	psf =	100.0	100.0
Short Term Factor	=		
Equiv. Solid Thick.	=		
Masonry Block Type	=	Medium Weight	
Masonry Design Method	=	ASD	

Concrete Data

f'c	psi =	3,000.0	3,000.0
Fy	psi =	60,000.0	60,000.0

Use menu item Settings > Printing & Title Block
to set these five lines of information
for your program.

Project Name/Number : fnd walls

Title 12' Basement Wall

Dsgnr: NJD

Description....

DTL 6

Page : 2
Date: 21 DEC 2020

This Wall in File: P:\Client Files\244 - McCullough Architects\2020\20019 - Barcelo Homes - Lot 1 -

RetainPro (c) 1987-2019, Build 11.20.03.31

License : KW-06059959

License To : MULHERN & KULP STRUCTURAL ENGINEERING INC

Cantilevered Retaining Wall

Code: IBC 2015,ACI 318-14,ACI 530-13

Concrete Stem Rebar Area Details

2nd Stem	Vertical Reinforcing	Horizontal Reinforcing
As (based on applied moment) :	0.2722 in ² /ft	
(4/3) * As :	0.3629 in ² /ft	Min Stem T&S Reinf Area 1.536 in ²
200bd/fy : 200(12)(6.5)/60000 :	0.26 in ² /ft	Min Stem T&S Reinf Area per ft of stem Height : 0.192 in ² /ft
0.0018bh : 0.0018(12)(8) :	0.1728 in ² /ft	Horizontal Reinforcing Options :
	=====	One layer of : Two layers of :
Required Area :	0.2722 in ² /ft	#4@ 12.50 in #4@ 25.00 in
Provided Area :	0.44 in ² /ft	#5@ 19.38 in #5@ 38.75 in
Maximum Area :	1.0567 in ² /ft	#6@ 27.50 in #6@ 55.00 in

Bottom Stem	Vertical Reinforcing	Horizontal Reinforcing
As (based on applied moment) :	0.7868 in ² /ft	
(4/3) * As :	1.0491 in ² /ft	Min Stem T&S Reinf Area 0.768 in ²
200bd/fy : 200(12)(6.5)/60000 :	0.26 in ² /ft	Min Stem T&S Reinf Area per ft of stem Height : 0.192 in ² /ft
0.0018bh : 0.0018(12)(8) :	0.1728 in ² /ft	Horizontal Reinforcing Options :
	=====	One layer of : Two layers of :
Required Area :	0.7868 in ² /ft	#4@ 12.50 in #4@ 25.00 in
Provided Area :	0.88 in ² /ft	#5@ 19.38 in #5@ 38.75 in
Maximum Area :	1.0567 in ² /ft	#6@ 27.50 in #6@ 55.00 in

Footing Data

Toe Width	=	4.00 ft
Heel Width	=	3.50
Total Footing Width	=	7.50
Footing Thickness	=	12.00 in
Key Width	=	0.00 in
Key Depth	=	0.00 in
Key Distance from Toe	=	0.00 ft
f'c =	2,500 psi	Fy = 60,000 psi
Footing Concrete Density	=	150.00 pcf
Min. As %	=	0.0018
Cover @ Top	2.00	@ Btm.= 3.00 in

Footing Design Results

		<u>Toe</u>	<u>Heel</u>
Factored Pressure	=	2,363	0 psf
Mu' : Upward	=	185,579	1,021 ft-#
Mu' : Downward	=	17,280	7,195 ft-#
Mu: Design	=	14,025	6,174 ft-#
Actual 1-Way Shear	=	53.33	34.49 psi
Allow 1-Way Shear	=	75.00	75.00 psi
Toe Reinforcing	=	# 5 @ 8.00 in	
Heel Reinforcing	=	# 5 @ 8.00 in	
Key Reinforcing	=	None Spec'd	
Footing Torsion, Tu	=		0.00 ft-lbs
Footing Allow. Torsion, phi Tu	=		0.00 ft-lbs

If torsion exceeds allowable, provide supplemental design for footing torsion.

Other Acceptable Sizes & Spacings

Toe: #4@ 6.30 in, #5@ 9.76 in, #6@ 13.86 in, #7@ 18.90 in, #8@ 24.88 in, #9@ 31.
Heel: #4@ 9.25 in, #5@ 14.35 in, #6@ 20.37 in, #7@ 27.77 in, #8@ 36.57 in, #9@ 46
Key: No key defined

Min footing T&S reinf Area	1.94	in ²
Min footing T&S reinf Area per foot	0.26	in ² /ft
If one layer of horizontal bars:		If two layers of horizontal bars:
#4@ 9.26 in		#4@ 18.52 in
#5@ 14.35 in		#5@ 28.70 in
#6@ 20.37 in		#6@ 40.74 in

Use menu item Settings > Printing & Title Block
to set these five lines of information
for your program.

Project Name/Number : fnd walls

Title 12' Basement Wall

Dsgnr: NJD

Description....

DTL 6

Page : 3
Date: 21 DEC 2020

This Wall in File: P:\Client Files\244 - McCullough Architects\2020\20019 - Barcelo Homes - Lot 1 -

RetainPro (c) 1987-2019, Build 11.20.03.31

License : KW-06059959

License To : MULHERN & KULP STRUCTURAL ENGINEERING INC

Cantilevered Retaining Wall

Code: IBC 2015,ACI 318-14,ACI 530-13

Summary of Overturning & Resisting Forces & Moments

ItemOVERTURNING.....		RESISTING.....					
	Force lbs	Distance ft	Moment ft-#	Force lbs	Distance ft	Moment ft-#			
HL Act Pres (ab water tbl)	2,407.9	4.22	10,169.5	Soil Over HL (ab. water tbl)	3,637.2	6.08	22,126.0		
HL Act Pres (be water tbl)				Soil Over HL (bel. water tbl)		6.08	22,126.0		
Hydrostatic Force				Watre Table					
Buoyant Force	=			Sloped Soil Over Heel	=				
Surcharge over Heel	=	155.5	6.34	985.1	Surcharge Over Heel	=	127.5	6.08	775.6
Surcharge Over Toe	=			Adjacent Footing Load	=				
Adjacent Footing Load	=			Axial Dead Load on Stem	=	100.0	4.33	433.3	
Added Lateral Load	=			* Axial Live Load on Stem	=				
Load @ Stem Above Soil	=			Soil Over Toe	=				
Seismic Earth Load	=	1,020.3	6.34	6,463.7	Surcharge Over Toe	=			
	=			Stem Weight(s)	=	1,200.0	4.33	5,200.0	
	=			Earth @ Stem Transitions	=				
Total	=	3,583.8	O.T.M. =	17,618.3	Footing Weight	=	1,125.0	3.75	4,218.8
					Key Weight	=			
					Vert. Component	=			
Resisting/Overturning Ratio			=	1.86	Total =	6,189.7	lbs	R.M.=	32,753.7
Vertical Loads used for Soil Pressure =				6,189.7	lbs				

* Axial live load NOT included in total displayed, or used for overturning resistance, but is included for soil pressure calculation.

If seismic is included, the OTM and sliding ratios may be 1.1 per section 1807.2.3 of IBC.

Vertical component of active lateral soil pressure IS NOT considered in the calculation of Sliding Resistance.

Vertical component of active lateral soil pressure IS NOT considered in the calculation of Overturning Resistance.

Tilt

Horizontal Deflection at Top of Wall due to settlement of soil

(Deflection due to wall bending not considered)

Soil Spring Reaction Modulus 250.0 pci

Horizontal Defl @ Top of Wall (approximate only) 0.075 in

The above calculation is not valid if the heel soil bearing pressure exceeds that of the toe, because the wall would then tend to rotate into the retained soil.

Use menu item Settings > Printing & Title Block
to set these five lines of information
for your program.

Project Name/Number : fnd walls

Title 7' Wall at Deck

Dsgnr: NJD

Description....

Detail 7

Page : 1
Date: 22 DEC 2020

This Wall in File: P:\Client Files\244 - McCullough Architects\2020\20019 - Barcelo Homes - Lot 1 -

RetainPro (c) 1987-2019, Build 11.20.03.31

License : KW-06059959

License To : MULHERN & KULP STRUCTURAL ENGINEERING INC

Restrained Retaining Wall

Code: IBC 2015, ACI 318-14, ACI 530-13

Criteria

Retained Height	=	7.33 ft
Wall height above soil	=	0.67 ft
Total Wall Height	=	8.00 ft
Top Support Height	=	8.00 ft
Slope Behind Wall	=	0.00
Height of Soil over Toe	=	48.00 in

Soil Data

Allow Soil Bearing	=	2,000.0 psf
Equivalent Fluid Pressure Method		
At-Rest Heel Pressure	=	35.0 psf/ft
Passive Pressure	=	250.0 psf/ft
Soil Density	=	110.00 pcf
Footings Soil Frictior	=	0.400
Soil height to ignore for passive pressure	=	12.00 in

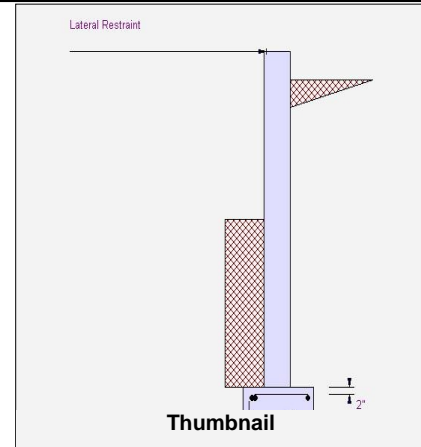

Surcharge Loads

Surcharge Over Heel	=	0.0 psf
>>>Used To Resist Sliding & Overturning		
Surcharge Over Toe	=	0.0 psf
Used for Sliding & Overturning		

Axial Load Applied to Stem

Axial Dead Load	=	0.0 lbs
Axial Live Load	=	0.0 lbs
Axial Load Eccentricity	=	0.0 in

Earth Pressure Seismic Load

Uniform Lateral Load Applied to Stem

Lateral Load	=	0.0 #/ft
...Height to Top	=	0.00 ft
...Height to Bottom	=	0.00 ft
Load Type	=	Wind (W) (Strength Level)

Wind on Exposed Stem = 0.0 psf

K_h Soil Density Multiplier = 0.200 g Added seismic per unit area = 0.0 psf

Adjacent Footing Load

Adjacent Footing Load	=	0.0 lbs
Footing Width	=	0.00 ft
Eccentricity	=	0.00 in
Wall to Ftg CL Dist	=	0.00 ft
Footing Type	=	Line Load
Base Above/Below Soil at Back of Wall	=	0.0 ft
Poisson's Ratio	=	0.300

Design Summary

Total Bearing Load	=	1,931 lbs
...resultant ecc.	=	3.88 in
Soil Pressure @ Toe	=	1,902 psf OK
Soil Pressure @ Heel	=	29 psf OK
Allowable	=	2,000 psf
Soil Pressure Less Than Allowable		
ACI Factored @ Toe	=	2,282 psf
ACI Factored @ Heel	=	35 psf
Footing Shear @ Toe	=	0.3 psi OK
Footing Shear @ Heel	=	4.3 psi OK
Allowable	=	75.0 psi
Reaction at Top	=	286.2 lbs
Reaction at Bottom	=	927.1 lbs
Sliding Stability Ratio	=	4.07 OK
Sliding Calcs		
Lateral Sliding Force	=	927.1 lbs
less 100% Passive Force	=	3,000.0 lbs
less 100% Friction Force	=	772.3 lbs
Added Force Req'd	=	0.0 lbs OK
...for 1.5 Stability	=	0.0 lbs OK

Concrete Stem Construction

Thickness	=	8.00 in	F_y	=	60,000 psi
Wall Weight	=	100.0 psf	f'_c	=	3,000 psi
Stem is FREE to rotate at top of footing					

	@ Top Support	Mmax Between Top & Base	@ Base of Wall
Design Height Above Ftg	8.00 ft	3.31 ft	0.00 ft
Rebar Size	# 5	# 5	# 5
Rebar Spacing	16.00 in	16.00 in	16.00 in
Rebar Placed at	Edge	Edge	Edge
Rebar Depth 'd'	5.50 in	6.00 in	5.50 in
Design Data			
fb/FB + fa/Fa	= 0.000	0.256	0.000
Mu....Actual	= 0.0 ft-#	1,548.7 ft-#	0.0 ft-#
Mn * Phi....Allowable	= 5,515.2 ft-#	6,038.3 ft-#	5,515.2 ft-#
Shear Force @ this height	= 459.5 lbs		1,044.9 lbs
Shear....Actual	= 6.96 psi		15.83 psi
Shear....Allowable	= 82.16 psi		82.16 psi

Vertical component of active lateral soil pressure IS NOT considered in the calculation of soil bearing

Load Factors

Building Code	IBC 2015, ACI
Dead Load	1.200
Live Load	1.600
Earth, H	1.600
Wind, W	1.000
Seismic, E	1.000

Use menu item Settings > Printing & Title Block
to set these five lines of information
for your program.

Project Name/Number : fnd walls

Title 7' Wall at Deck

Dsgnr: NJD

Description....

Detail 7

Page : 2
Date: 22 DEC 2020

This Wall in File: P:\Client Files\244 - McCullough Architects\2020\20019 - Barcelo Homes - Lot 1 -

RetainPro (c) 1987-2019, Build 11.20.03.31

License : KW-06059959

License To : MULHERN & KULP STRUCTURAL ENGINEERING INC

Restrained Retaining Wall

Code: IBC 2015,ACI 318-14,ACI 530-13

Concrete Stem Rebar Area Details

Top Support	Vertical Reinforcing	Horizontal Reinforcing
As (based on applied moment) :	0 in2/ft	
(4/3) * As :	0 in2/ft	Min Stem T&S Reinf Area 1.536 in2
200bd/fy : 200(12)(5.5)/60000 :	0.22 in2/ft	Min Stem T&S Reinf Area per ft of stem Height : 0.192 in2/ft
0.0018bh : 0.0018(12)(8) :	0.1728 in2/ft	Horizontal Reinforcing Options :
	=====	One layer of : Two layers of :
Required Area :	0.1728 in2/ft	#4@ 12.50 in #4@ 25.00 in
Provided Area :	0.2325 in2/ft	#5@ 19.38 in #5@ 38.75 in
Maximum Area :	0.8941 in2/ft	#6@ 27.50 in #6@ 55.00 in

Mmax Between Ends	Vertical Reinforcing	Horizontal Reinforcing
As (based on applied moment) :	0.0606 in2/ft	
(4/3) * As :	0.0808 in2/ft	Min Stem T&S Reinf Area 0.901 in2
200bd/fy : 200(12)(6)/60000 :	0.24 in2/ft	Min Stem T&S Reinf Area per ft of stem Height : 0.192 in2/ft
0.0018bh : 0.0018(12)(8) :	0.1728 in2/ft	Horizontal Reinforcing Options :
	=====	One layer of : Two layers of :
Required Area :	0.1728 in2/ft	#4@ 12.50 in #4@ 25.00 in
Provided Area :	0.2325 in2/ft	#5@ 19.38 in #5@ 38.75 in
Maximum Area :	0.9754 in2/ft	#6@ 27.50 in #6@ 55.00 in

Base Support	Vertical Reinforcing	Horizontal Reinforcing
As (based on applied moment) :	0 in2/ft	
(4/3) * As :	0 in2/ft	Min Stem T&S Reinf Area 0.635 in2
200bd/fy : 200(12)(5.5)/60000 :	0.22 in2/ft	Min Stem T&S Reinf Area per ft of stem Height : 0.192 in2/ft
0.0018bh : 0.0018(12)(8) :	0.1728 in2/ft	Horizontal Reinforcing Options :
	=====	One layer of : Two layers of :
Required Area :	0.1728 in2/ft	#4@ 12.50 in #4@ 25.00 in
Provided Area :	0.2325 in2/ft	#5@ 19.38 in #5@ 38.75 in
Maximum Area :	0.8941 in2/ft	#6@ 27.50 in #6@ 55.00 in

Footing Strengths & Dimensions

Toe Width	=	0.67 ft
Heel Width	=	1.33
Total Footing Width	=	2.00
Footing Thickness	=	12.00 in
Key Width	=	0.00 in
Key Depth	=	0.00 in
Key Distance from Toe	=	0.00 ft
f'c =	2,500 psi	Fy = 60,000 psi
Footing Concrete Density	=	150.00 pcf
Min. As %	=	0.0018
Cover @ Top	=	2.00 in @ Btm.= 3.00 in

Footing Design Results

	Toe	Heel
Factored Pressure	= 2,282	35 psf
Mu' : Upward	= 452	63 ft-#
Mu' : Downward	= 157	255 ft-#
Mu: Design	= 294	192 ft-#
Actual 1-Way Shear	= 0.29	4.32 psi
Allow 1-Way Shear	= 75.00	75.00 psi

Other Acceptable Sizes & Spacings:

Toe: # 4 @ 8.00 in	-or-	phiMn = phi'5'lambda'sqrt(fc)'Sm
Heel: # 4 @ 8.00 in	-or-	phiMn = phi'5'lambda'sqrt(fc)'Sm
Key: No key defined	-or-	No key defined
Min footing T&S reinf Area		0.52 in2
Min footing T&S reinf Area per foot		0.26 in2 /ft
If one layer of horizontal bars:		If two layers of horizontal bars:
#4@ 9.26 in		#4@ 18.52 in
#5@ 14.35 in		#5@ 28.70 in
#6@ 20.37 in		#6@ 40.74 in

Use menu item Settings > Printing & Title Block
to set these five lines of information
for your program.

Project Name/Number : fnd walls

Title 7' Wall at Deck

Dsgnr: NJD

Description....

Detail 7

Page : 3
Date: 22 DEC 2020

This Wall in File: P:\Client Files\244 - McCullough Architects\2020\20019 - Barcelo Homes - Lot 1 -

RetainPro (c) 1987-2019, Build 11.20.03.31

License : KW-06059959

License To : MULHERN & KULP STRUCTURAL ENGINEERING INC

Restrained Retaining Wall

Code: IBC 2015,ACI 318-14,ACI 530-13

Summary of Forces on Footing : Slab is NOT resisting sliding, stem is PINNED at footing

Forces acting on footing for overturning, sliding, & soil pressure

Overturning Moments...	Lateral lbs	Distance ft	Moment ft-#
Stem Shear @ Top of Footing =	-653.1	1.00	-653.1
Heel Active Pressure =	-274.1	0.49	-134.1
Sliding Force	= 927.1		
Overturing Moment =			-787.2

Footing Overturing Stability Ratio 2.66

Net Moment Used For Soil Pressure Calculations **624.4 ft-#**

Net Mom. at Stem/Ftg Interface = 624.4 ft-#

Allow. Mom. @ Stem/Ftg Interface = 3,447.0 ft-#

Allow. Mom. Exceeds Applied Mom.? Yes

Therefore Uniform Soil Pressure = 965.4 psf

Resisting Moments...	Vertical lbs	Lateral lbs	Distance ft	Moment ft-#
Surcharge Over Heel =				
Adjacent Footing Load =				
Axial Dead Load on Stem =				
Soil Over Toe =	293.3		0.33	97.8
Stem Weight =	800.0			
Surcharge Over Toe =			1.00	800.0
Soil Over Heel =	537.5		1.67	895.9
Footing Weight =	300.0		1.00	300.0
Total Vertical Force =	1,930.9 lbs			
Resisting Moment =				2,093.7

Vertical component of active lateral soil pressure IS NOT considered in the calculation of Sliding Resistance.

Use menu item Settings > Printing & Title Block
to set these five lines of information
for your program.

Project Name/Number : fnd walls
Title 7' Wall at Deck (@ dropping grade)
Dsgnr: NJD
Description....
Detail 7

Page : 1
Date: 22 DEC 2020

This Wall in File: P:\Client Files\244 - McCullough Architects\2020\20019 - Barcelo Homes - Lot 1 -

RetainPro (c) 1987-2019, Build 11.20.03.31
License : KW-06059959
License To : MULHERN & KULP STRUCTURAL ENGINEERING INC

Restrained Retaining Wall

Code: IBC 2015,ACI 318-14,ACI 530-13

Criteria

Retained Height	=	5.00 ft
Wall height above soil	=	3.00 ft
Total Wall Height	=	8.00 ft
Top Support Height	=	7.00 ft
Slope Behind Wall	=	0.00
Height of Soil over Toe	=	12.00 in

Soil Data

Allow Soil Bearing	=	2,000.0 psf
Equivalent Fluid Pressure Method		
At-Rest Heel Pressure	=	35.0 psf/ft
Passive Pressure	=	250.0 psf/ft
Soil Density	=	110.00 pcf
Footings Soil Frictior	=	0.400
Soil height to ignore for passive pressure	=	12.00 in

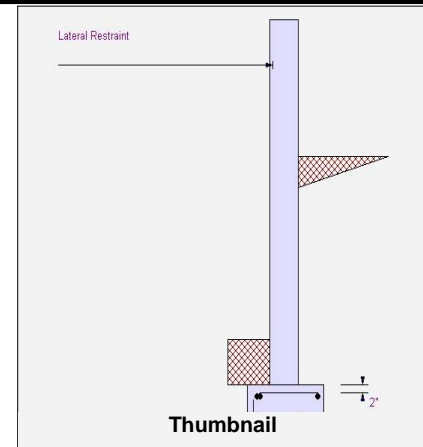

Surcharge Loads

Surcharge Over Heel	=	0.0 psf
>>>Used To Resist Sliding & Overturning		
Surcharge Over Toe	=	0.0 psf
Used for Sliding & Overturning		

Axial Load Applied to Stem

Axial Dead Load	=	0.0 lbs
Axial Live Load	=	0.0 lbs
Axial Load Eccentricity	=	0.0 in

Earth Pressure Seismic Load

Uniform Lateral Load Applied to Stem

Lateral Load	=	0.0 #/ft
...Height to Top	=	0.00 ft
...Height to Bottom	=	0.00 ft
Load Type	=	Wind (W) (Strength Level)

Wind on Exposed Stem = 0.0 psf

K_h Soil Density Multiplier = 0.200 g Added seismic per unit area = 0.0 psf

Adjacent Footing Load

Adjacent Footing Load	=	0.0 lbs
Footing Width	=	0.00 ft
Eccentricity	=	0.00 in
Wall to Ftg CL Dist	=	0.00 ft
Footing Type	=	Line Load
Base Above/Below Soil at Back of Wall	=	0.0 ft
Poisson's Ratio	=	0.300

Design Summary

Total Bearing Load	=	1,540 lbs
...resultant ecc.	=	1.80 in
Soil Pressure @ Toe	=	1,117 psf OK
Soil Pressure @ Heel	=	423 psf OK
Allowable	=	2,000 psf
Soil Pressure Less Than Allowable		
ACI Factored @ Toe	=	1,340 psf
ACI Factored @ Heel	=	508 psf
Footing Shear @ Toe	=	0.1 psi OK
Footing Shear @ Heel	=	1.1 psi OK
Allowable	=	75.0 psi
Reaction at Top	=	103.2 lbs
Reaction at Bottom	=	525.8 lbs
Sliding Stability Ratio	=	1.88 OK
Sliding Calcs		
Lateral Sliding Force	=	525.8 lbs
less 100% Passive Force	=	375.0 lbs
less 100% Friction Force	=	616.0 lbs
Added Force Req'd	=	0.0 lbs OK
....for 1.5 Stability	=	0.0 lbs OK

Concrete Stem Construction

Thickness	=	8.00 in	F_y	=	60,000 psi
Wall Weight	=	100.0 psf	f'_c	=	3,000 psi
Stem is FREE to rotate at top of footing					

	@ Top Support	Mmax Between Top & Base	@ Base of Wall
Design Height Above Ftg	Stem OK	Stem OK	Stem OK
Rebar Size	# 5	# 5	# 5
Rebar Spacing	16.00 in	16.00 in	16.00 in
Rebar Placed at	Edge	Edge	Edge
Rebar Depth 'd'	5.50 in	6.00 in	5.50 in
Design Data			
fb/FB + fa/Fa	= 0.000	0.100	0.000
Mu....Actual	= 0.0 ft-#	604.4 ft-#	0.0 ft-#
Mn * Phi....Allowable	= 5,515.2 ft-#	6,038.3 ft-#	5,515.2 ft-#
Shear Force @ this height	= 166.7 lbs		533.3 lbs
Shear....Actual	= 2.53 psi		8.08 psi
Shear....Allowable	= 82.16 psi		82.16 psi

Vertical component of active lateral soil pressure IS NOT considered in the calculation of soil bearing

Load Factors

Building Code	IBC 2015,ACI
Dead Load	1.200
Live Load	1.600
Earth, H	1.600
Wind, W	1.000
Seismic, E	1.000

Use menu item Settings > Printing & Title Block
to set these five lines of information
for your program.

Project Name/Number : fnd walls
Title 7' Wall at Deck (@ dropping grade)
Dsgnr: NJD
Description....
Detail 7

Page : 2
Date: 22 DEC 2020

This Wall in File: P:\Client Files\244 - McCullough Architects\2020\20019 - Barcelo Homes - Lot 1 -

RetainPro (c) 1987-2019, Build 11.20.03.31
License : KW-06059959
License To : MULHERN & KULP STRUCTURAL ENGINEERING INC

Restrained Retaining Wall

Code: IBC 2015,ACI 318-14,ACI 530-13

Concrete Stem Rebar Area Details

Top Support	Vertical Reinforcing	Horizontal Reinforcing
As (based on applied moment) :	0 in2/ft	
(4/3) * As :	0 in2/ft	Min Stem T&S Reinf Area 1.344 in2
200bd/fy : 200(12)(5.5)/60000 :	0.22 in2/ft	Min Stem T&S Reinf Area per ft of stem Height : 0.192 in2/ft
0.0018bh : 0.0018(12)(8) :	0.1728 in2/ft	Horizontal Reinforcing Options :
	=====	One layer of : Two layers of :
Required Area :	0.1728 in2/ft	#4@ 12.50 in #4@ 25.00 in
Provided Area :	0.2325 in2/ft	#5@ 19.38 in #5@ 38.75 in
Maximum Area :	0.8941 in2/ft	#6@ 27.50 in #6@ 55.00 in

Mmax Between Ends	Vertical Reinforcing	Horizontal Reinforcing
As (based on applied moment) :	0.0236 in2/ft	
(4/3) * As :	0.0315 in2/ft	Min Stem T&S Reinf Area 0.847 in2
200bd/fy : 200(12)(6)/60000 :	0.24 in2/ft	Min Stem T&S Reinf Area per ft of stem Height : 0.192 in2/ft
0.0018bh : 0.0018(12)(8) :	0.1728 in2/ft	Horizontal Reinforcing Options :
	=====	One layer of : Two layers of :
Required Area :	0.1728 in2/ft	#4@ 12.50 in #4@ 25.00 in
Provided Area :	0.2325 in2/ft	#5@ 19.38 in #5@ 38.75 in
Maximum Area :	0.9754 in2/ft	#6@ 27.50 in #6@ 55.00 in

Base Support	Vertical Reinforcing	Horizontal Reinforcing
As (based on applied moment) :	0 in2/ft	
(4/3) * As :	0 in2/ft	Min Stem T&S Reinf Area 0.497 in2
200bd/fy : 200(12)(5.5)/60000 :	0.22 in2/ft	Min Stem T&S Reinf Area per ft of stem Height : 0.192 in2/ft
0.0018bh : 0.0018(12)(8) :	0.1728 in2/ft	Horizontal Reinforcing Options :
	=====	One layer of : Two layers of :
Required Area :	0.1728 in2/ft	#4@ 12.50 in #4@ 25.00 in
Provided Area :	0.2325 in2/ft	#5@ 19.38 in #5@ 38.75 in
Maximum Area :	0.8941 in2/ft	#6@ 27.50 in #6@ 55.00 in

Footing Strengths & Dimensions

Toe Width	=	0.67 ft
Heel Width	=	1.33
Total Footing Width	=	2.00
Footing Thickness	=	12.00 in
Key Width	=	0.00 in
Key Depth	=	0.00 in
Key Distance from Toe	=	0.00 ft
f'c =	2,500 psi	Fy = 60,000 psi
Footing Concrete Density	=	150.00 pcf
Min. As %	=	0.0018
Cover @ Top	=	2.00 in @ Btm.= 3.00 in

Footing Design Results

	Toe	Heel
Factored Pressure	= 1,340	508 psf
Mu' : Upward	= 277	133 ft-#
Mu' : Downward	= 69	187 ft-#
Mu: Design	= 208	53 ft-#
Actual 1-Way Shear	= 0.13	1.13 psi
Allow 1-Way Shear	= 75.00	75.00 psi

Other Acceptable Sizes & Spacings:

Toe: # 4 @ 8.00 in	-or-	phiMn = phi'5'lambda'sqrt(fc)'Sm
Heel: # 4 @ 8.00 in	-or-	phiMn = phi'5'lambda'sqrt(fc)'Sm
Key: No key defined	-or-	No key defined
Min footing T&S reinf Area		0.52 in2
Min footing T&S reinf Area per foot		0.26 in2 /ft
If one layer of horizontal bars:		If two layers of horizontal bars:
#4@ 9.26 in		#4@ 18.52 in
#5@ 14.35 in		#5@ 28.70 in
#6@ 20.37 in		#6@ 40.74 in

Use menu item Settings > Printing & Title Block
to set these five lines of information
for your program.

Project Name/Number : fnd walls
Title 7' Wall at Deck (@ dropping grade)
Dsgnr: NJD
Description....
Detail 7

Page : 3
Date: 22 DEC 2020

This Wall in File: P:\Client Files\244 - McCullough Architects\2020\20019 - Barcelo Homes - Lot 1 -

RetainPro (c) 1987-2019, Build 11.20.03.31
License : KW-06059959
License To : MULHERN & KULP STRUCTURAL ENGINEERING INC

Restrained Retaining Wall

Code: IBC 2015,ACI 318-14,ACI 530-13

Summary of Forces on Footing : Slab is NOT resisting sliding, stem is PINNED at footing

Forces acting on footing for overturning, sliding, & soil pressure

Overturning Moments...	Lateral lbs	Distance ft	Moment ft-#
Stem Shear @ Top of Footing =	-333.3	1.00	-333.3
Heel Active Pressure =	-192.5	0.48	-93.3
Sliding Force =	525.8		
Overturning Moment =			-426.7

Footing Overturning Stability Ratio 4.07

Net Moment Used For Soil Pressure Calculations **231.1 ft-#**

Net Mom. at Stem/Ftg Interface = 231.1 ft-#

Allow. Mom. @ Stem/Ftg Interface = 3,447.0 ft-#

Allow. Mom. Exceeds Applied Mom.? Yes

Therefore Uniform Soil Pressure = 770.0 psf

Resisting Moments...	Vertical lbs	Lateral lbs	Distance ft	Moment ft-#
Surcharge Over Heel =				
Adjacent Footing Load =				
Axial Dead Load on Stem =				
Soil Over Toe =	73.3		0.33	24.4
Stem Weight =	800.0			
Surcharge Over Toe =			1.00	800.0
Soil Over Heel =	366.7		1.67	611.1
Footing Weight =	300.0		1.00	300.0
Total Vertical Force =	1,540.0 lbs			
Resisting Moment =				1,735.6

Vertical component of active lateral soil pressure IS NOT considered in the calculation of Sliding Resistance.

Use menu item Settings > Printing & Title Block
to set these five lines of information
for your program.

Project Name/Number : fnd walls

Title Cant: Wall at Patio

Dsgnr: NJD

Description....

Detail 9

Page : 1
Date: 22 DEC 2020

This Wall in File: P:\Client Files\244 - McCullough Architects\2020\20019 - Barcelo Homes - Lot 1 -

RetainPro (c) 1987-2019, Build 11.20.03.31

License : KW-06059959

License To : MULHERN & KULP STRUCTURAL ENGINEERING INC

Cantilevered Retaining Wall

Code: IBC 2015,ACI 318-14,ACI 530-13

Criteria

Retained Height	=	5.00 ft
Wall height above soil	=	0.67 ft
Slope Behind Wall	=	0.00
Height of Soil over Toe	=	0.00 in
Water height over heel	=	0.0 ft

Soil Data

Allow Soil Bearing	=	2,000.0 psf
Equivalent Fluid Pressure Method		
Active Heel Pressure	=	35.0 psf/ft
	=	
Passive Pressure	=	250.0 psf/ft
Soil Density, Heel	=	110.0 pcf
Soil Density, Toe	=	0.00 pcf
Footing Soil Friction	=	0.400
Soil height to ignore for passive pressure	=	12.00 in

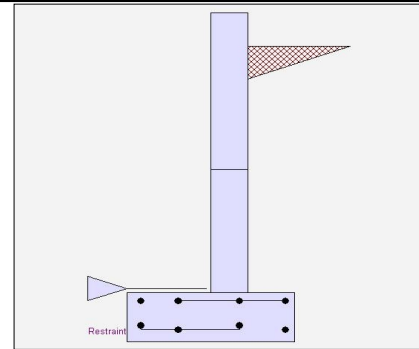

Surcharge Loads

Surcharge Over Heel	=	0.0 psf
Used To Resist Sliding & Overturning		
Surcharge Over Toe	=	0.0 psf
Used for Sliding & Overturning		

Lateral Load Applied to Stem

Lateral Load	=	0.0 #/ft
...Height to Top	=	0.00 ft
...Height to Bottom	=	0.00 ft
Load Type	=	Wind (W) (Service Level)
Wind on Exposed Stem	=	0.0 psf (Service Level)

Adjacent Footing Load

Adjacent Footing Load	=	0.0 lbs
Footing Width	=	0.00 ft
Eccentricity	=	0.00 in
Wall to Ftg CL Dist	=	0.00 ft
Footing Type	=	Line Load
Base Above/Below Soil at Back of Wall	=	0.0 ft
Poisson's Ratio	=	0.300

Axial Load Applied to Stem

Axial Dead Load	=	0.0 lbs
Axial Live Load	=	0.0 lbs
Axial Load Eccentricity	=	0.0 in

Earth Pressure Seismic Load

Method : Uniform		
Multiplier Used	=	5.750
(Multiplier used on soil density)		
Uniform Seismic Force	=	34.500
Total Seismic Force	=	207.000

Design Summary

Wall Stability Ratios

Overturning	=	1.71 OK
Slab Resists All Sliding !		

Total Bearing Load	=	1,475 lbs
...resultant ecc.	=	8.21 in

Soil Pressure @ Toe	=	1,205 psf OK
Soil Pressure @ Heel	=	0 psf OK
Allowable	=	2,000 psf
Soil Pressure Less Than Allowable		

ACI Factored @ Toe	=	1,688 psf
ACI Factored @ Heel	=	0 psf
Footing Shear @ Toe	=	9.6 psi OK
Footing Shear @ Heel	=	5.9 psi OK
Allowable	=	75.0 psi

Sliding Calcs

Lateral Sliding Force	=	774.9 lbs
-----------------------	---	-----------

Stem Construction

	2nd	Bottom
Design Height Above Ftg	ft = 2.50	Stem OK 0.00
Wall Material Above "Ht"	= Concrete	Concrete
Design Method	= LRFD	LRFD
Thickness	= 8.00	8.00
Rebar Size	= # 5	# 5
Rebar Spacing	= 16.00	16.00
Rebar Placed at	= Edge	Edge

Design Data

fb/FB + fa/Fa	=	0.040	0.256
---------------	---	-------	-------

Total Force @ Section

Service Level	lbs =		
Strength Level	lbs =	261.3	872.5

Moment....Actual

Service Level	ft-# =		
Strength Level	ft-# =	253.6	1,597.9
Moment....Allowable	ft-# =	6,234.5	6,234.5

Shear.....Actual

Service Level	psi =		
Strength Level	psi =	3.5	11.8
Shear....Allowable	psi =	82.2	82.2
Anet (Masonry)	in2 =		
Rebar Depth 'd'	in =	6.19	6.19

Masonry Data

f'm	psi =		
Fs	psi =		
Solid Grouting	=		
Modular Ratio 'n'	=		
Wall Weight	psf =	100.0	100.0
Short Term Factor	=		
Equiv. Solid Thick.	=		
Masonry Block Type	=	Medium Weight	
Masonry Design Method	=	ASD	

Concrete Data

f'c	psi =	3,000.0	3,000.0
Fy	psi =	60,000.0	60,000.0

Vertical component of active lateral soil pressure IS
NOT considered in the calculation of soil bearing

Load Factors

Building Code	IBC 2015,ACI
Dead Load	1.200
Live Load	1.600
Earth, H	1.600
Wind, W	1.000
Seismic, E	1.000

Use menu item Settings > Printing & Title Block
to set these five lines of information
for your program.

Project Name/Number : fnd walls

Title Cant: Wall at Patio

Dsgnr: NJD

Description....

Detail 9

Page : 2
Date: 22 DEC 2020

This Wall in File: P:\Client Files\244 - McCullough Architects\2020\20019 - Barcelo Homes - Lot 1 -

RetainPro (c) 1987-2019, Build 11.20.03.31

License : KW-06059959

License To : MULHERN & KULP STRUCTURAL ENGINEERING INC

Cantilevered Retaining Wall

Code: IBC 2015,ACI 318-14,ACI 530-13

Concrete Stem Rebar Area Details

2nd Stem	Vertical Reinforcing	Horizontal Reinforcing
As (based on applied moment) :	0.0096 in ² /ft	
(4/3) * As :	0.0128 in ² /ft	Min Stem T&S Reinf Area 0.609 in ²
200bd/fy : 200(12)(6.1875)/60000 :	0.2475 in ² /ft	Min Stem T&S Reinf Area per ft of stem Height : 0.192 in ² /ft
0.0018bh : 0.0018(12)(8) :	0.1728 in ² /ft	Horizontal Reinforcing Options :
	=====	One layer of : Two layers of :
Required Area :	0.1728 in ² /ft	#4@ 12.50 in #4@ 25.00 in
Provided Area :	0.2325 in ² /ft	#5@ 19.38 in #5@ 38.75 in
Maximum Area :	1.0059 in ² /ft	#6@ 27.50 in #6@ 55.00 in

Bottom Stem	Vertical Reinforcing	Horizontal Reinforcing
As (based on applied moment) :	0.0605 in ² /ft	
(4/3) * As :	0.0807 in ² /ft	Min Stem T&S Reinf Area 0.480 in ²
200bd/fy : 200(12)(6.1875)/60000 :	0.2475 in ² /ft	Min Stem T&S Reinf Area per ft of stem Height : 0.192 in ² /ft
0.0018bh : 0.0018(12)(8) :	0.1728 in ² /ft	Horizontal Reinforcing Options :
	=====	One layer of : Two layers of :
Required Area :	0.1728 in ² /ft	#4@ 12.50 in #4@ 25.00 in
Provided Area :	0.2325 in ² /ft	#5@ 19.38 in #5@ 38.75 in
Maximum Area :	1.0059 in ² /ft	#6@ 27.50 in #6@ 55.00 in

Footing Data

Toe Width	=	1.50 ft
Heel Width	=	1.50
Total Footing Width	=	3.00
Footing Thickness	=	12.00 in
Key Width	=	0.00 in
Key Depth	=	0.00 in
Key Distance from Toe	=	0.00 ft
f'c =	2,500 psi	Fy = 60,000 psi
Footing Concrete Density	=	150.00 pcf
Min. As %	=	0.0018
Cover @ Top	2.00	@ Btm = 3.00 in

Footing Design Results

	Toe	Heel
Factored Pressure	= 1,688	0 psf
Mu' : Upward	= 18,128	3 ft-#
Mu' : Downward	= 2,430	292 ft-#
Mu: Design	= 1,308	289 ft-#
Actual 1-Way Shear	= 9.58	5.90 psi
Allow 1-Way Shear	= 75.00	75.00 psi
Toe Reinforcing	= # 4 @ 9.25 in	
Heel Reinforcing	= # 4 @ 9.25 in	
Key Reinforcing	= None Spec'd	
Footing Torsion, Tu	=	0.00 ft-lbs
Footing Allow. Torsion, phi Tu	=	0.00 ft-lbs

If torsion exceeds allowable, provide supplemental design for footing torsion.

Other Acceptable Sizes & Spacings

Toe: #4@ 9.25 in, #5@ 14.35 in, #6@ 20.37 in, #7@ 27.77 in, #8@ 36.57 in, #9@ 46
Heel: #4@ 9.25 in, #5@ 14.35 in, #6@ 20.37 in, #7@ 27.77 in, #8@ 36.57 in, #9@ 46
Key: No key defined

Min footing T&S reinf Area	0.78	in ²
Min footing T&S reinf Area per foot	0.26	in ² /ft
If one layer of horizontal bars:		If two layers of horizontal bars:
#4@ 9.26 in		#4@ 18.52 in
#5@ 14.35 in		#5@ 28.70 in
#6@ 20.37 in		#6@ 40.74 in

Use menu item Settings > Printing & Title Block
to set these five lines of information
for your program.

Project Name/Number : fnd walls

Title Cant: Wall at Patio

Dsgnr: NJD

Description....

Detail 9

Page : 3
Date: 22 DEC 2020

This Wall in File: P:\Client Files\244 - McCullough Architects\2020\20019 - Barcelo Homes - Lot 1 -

RetainPro (c) 1987-2019, Build 11.20.03.31

License : KW-06059959

License To : MULHERN & KULP STRUCTURAL ENGINEERING INC

Cantilevered Retaining Wall

Code: IBC 2015,ACI 318-14,ACI 530-13

Summary of Overturning & Resisting Forces & Moments

ItemOVERTURNING.....		RESISTING.....			
	Force lbs	Distance ft	Moment ft-#	Force lbs	Distance ft	Moment ft-#	
HL Act Pres (ab water tbl)	630.0	2.00	1,260.0	Soil Over HL (ab. water tbl)	458.3	2.58	1,184.0
HL Act Pres (be water tbl)				Soil Over HL (bel. water tbl)		2.58	1,184.0
Hydrostatic Force				Watre Table			
Buoyant Force =				Sloped Soil Over Heel =			
Surcharge over Heel =				Surcharge Over Heel =			
Surcharge Over Toe =				Adjacent Footing Load =			
Adjacent Footing Load =				Axial Dead Load on Stem =			
Added Lateral Load =				* Axial Live Load on Stem =			
Load @ Stem Above Soil =				Soil Over Toe =			
Seismic Earth Load =	144.9	3.00	434.7	Surcharge Over Toe =			
				Stem Weight(s) =	567.0	1.83	1,039.5
Total	774.9	O.T.M. =	1,694.7	Earth @ Stem Transitions =			
				Footing Weight =	450.0	1.50	675.0
				Key Weight =			
				Vert. Component =			
Resisting/Overturning Ratio		=	1.71	Total =	1,475.3 lbs	R.M.=	2,898.5
Vertical Loads used for Soil Pressure =		1,475.3 lbs					

* Axial live load NOT included in total displayed, or used for overturning resistance, but is included for soil pressure calculation.

If seismic is included, the OTM and sliding ratios may be 1.1 per section 1807.2.3 of IBC.

Vertical component of active lateral soil pressure IS NOT considered in the calculation of Sliding Resistance.

Vertical component of active lateral soil pressure IS NOT considered in the calculation of Overturning Resistance.

Tilt

Horizontal Deflection at Top of Wall due to settlement of soil

(Deflection due to wall bending not considered)

Soil Spring Reaction Modulus 250.0 pci

Horizontal Defl @ Top of Wall (approximate only) 0.063 in

The above calculation is not valid if the heel soil bearing pressure exceeds that of the toe, because the wall would then tend to rotate into the retained soil.

MCCULLOUGH ARCHITECTS

BARCELO HOMES - LOT 1

MERCER ISLAND, WA

SHEAR WALL CALCULATIONS - WIND DESIGN

REVIEWED BY: NJM

DECEMBER 7, 2020

PARAMETERS:

SINGLE FAMILY HOME

DESIGN WIND SPEED: 110 MPH

WIND EXPOSURE CATEGORY: C

SEISMIC DESIGN CATEGORY: D

CODE & DESIGN STANDARD: 2018 IBC CH. 1609, ASCE 7-16 CH. 26-30



MULHERN+KULP
RESIDENTIAL STRUCTURAL ENGINEERING

WIND DESIGN SUMMARY PER ASCE 7-16

PARAMETERS:				ROOF GEOMETRY:				BUILDING GEOMETRY:			
WIND SPEED	100	TRANS. ROOF PITCH	4.0 :12	LENGTH	72	FT					
EXPOSURE CATEGORY	C	LONG. ROOF PITCH	4.0 :12	WIDTH	71	FT					
RISK CATEGORY	II	MEAN ROOF HEIGHT, H	37.00 FT	NUMBER OF STORIES	3						
WIND DIRECTIONALITY FACTOR, K_D	0.85										
TOPOGRAPHIC FACTOR, K_{ZT}	1.00										
GUST FACTOR, G	0.85										
GROUND ELEV. ABOVE SEA LEVEL (FT)	0										
DESIGN TYPE	ASD										
	0.60										

TRANSVERSE DIRECTION (PERPENDICULAR TO MAIN RIDGE LINE)												
		TRIBUTARY DESIGN AREAS:				TRIBUTARY DESIGN LOADS: (0.6W)						
DIAPHRAGM LEVEL	FLOOR-TO-FLOOR HEIGHT		SECTION			SECTION						
			A	O	B	A	O	B	A	O	B	
3	10 FT	Roof Surface	0	156	0	0	7.46	0.00	0.00	7.46	0.00	0.00
		Wall surface	0	440	0	0.00	7.46	0.00	0.00	7.46	0.00	0.00
2	12.5 FT	Roof Surface	0	0	0	0.00	10.40	0.00	0.00	10.40	0.00	0.00
		Wall surface	0	740	0	0.00	17.86	0.00	0.00	17.86	0.00	0.00
1	12 FT	Roof Surface	0	0	0	0.00	8.48	0.00	0.00	8.48	0.00	0.00
		Wall surface	0	641	0	0.00	26.34	0.00	0.00	26.34	0.00	0.00
FND		Roof Surface	0	0	0	0.00	0.00	0.00	0.00	0.00	0.00	0.00
	Wall surface	0	0	0	0.00	26.34	0.00	0.00	26.34	0.00	0.00	

LONGITUDINAL DIRECTION (PARALLEL TO MAIN RIDGE LINE)												
		TRIBUTARY DESIGN AREAS:				TRIBUTARY DESIGN LOADS: (0.6W)						
DIAPHRAGM LEVEL	FLOOR-TO-FLOOR HEIGHT		SECTION			SECTION						
			A	O	B	A	O	B	A	O	B	
3	10 FT	Roof Surface	0	154	0	0.00	7.65	0.00	0.00	7.65	0.00	0.00
		Wall surface	0	455	0	0.00	7.65	0.00	0.00	7.65	0.00	0.00
2	12.5 FT	Roof Surface	0	0	0	0.00	10.94	0.00	0.00	10.94	0.00	0.00
		Wall surface	0	780	0	0.00	18.58	0.00	0.00	18.58	0.00	0.00
1	12 FT	Roof Surface	0	0	0	0.00	6.34	0.00	0.00	6.34	0.00	0.00
		Wall surface	0	480	0	0.00	24.92	0.00	0.00	24.92	0.00	0.00
FND		Roof Surface	0	0	0	0.00	0.00	0.00	0.00	0.00	0.00	0.00
	Wall surface	0	0	0	0.00	24.92	0.00	0.00	24.92	0.00	0.00	

GENERAL NOTES:

1. DIMENSION LINES ARE TO FACE OF STUD U.N.O.
2. WINDOW SIZES & ROUGH OPENINGS TO BE VERIFIED BY CONTRACTOR.
3. IF NOMINAL DOOR AND WINDOW HEIGHTS ARE SIMILAR, COORDINATE WITH DOOR AND WINDOW SPECS TO LOCATE FINAL ELEVATION OF THE HEAD HEIGHTS SO THAT ALL DOOR AND WINDOW TRIM ALIGN.
4. WINDOW AND DOOR SIZES ARE DIMENSIONED IN FEET AND INCHES (E.G. 2828= 2'-8" W X 2'-8" H).
5. EXTERIOR WALLS TO BE 2X6 STUDS PER STRUCTURAL, INTERIOR WALLS TO BE 2X4 STUDS PER STRUCTURAL.
6. FIREBLOCK ALL PLUMBING PENETRATIONS AND STAIR RUNS PER IRC SEC. R302.11.
7. ALL WOOD IN CONTACT WITH CONCRETE TO BE PRESSURE TREATED PER IRC SEC. R317.1.
8. PROVIDE UNDER-STAIR PROTECTION (1/2" GWB) PER IRC SEC R302.7.
9. PROVIDE (1) LAYER OF 1/2" GWB AT THE GARAGE SIDE OF ALL WALLS SEPARATING THE GARAGE FROM THE RESIDENCE, ALL WALLS SUPPORTING A FLOOR CEILING ASSEMBLY BETWEEN THE GARAGE AND RESIDENCE, AND BETWEEN THE GARAGE AND ITS ATTIC. PROVIDE (1) LAYER 5/8" TYPE X GWB TO GARAGE CEILING IF BELOW HABITABLE ROOMS.
10. HOUSE/GARAGE DOOR SHALL BE 1-3/4" THICK WOOD SOLID CORE, OR 1-3/4" THICK SOLID OR HONEYCOMB CORE STEEL DOOR, OR 20-MINUTE RATED FIRE DOOR. PROVIDE SELF-CLOSING DEVICE.
11. DUCTS IN THE GARAGE AND DUCTS PENETRATING THE WALLS AND CEILINGS SEPARATING THE DWELLING FROM THE GARAGE SHALL BE MIN. 26 GAUGE GALVANIZED STEEL.
12. PER IRC SEC R311.7.5, MAX. RISER HEIGHT SHALL BE 7-3/4". MAX. TREAD SHALL BE 10". STAIR NOSINGS: 3/4" MIN., 1-1/4" MAX. RADIUS. TREAD: 9/16" MAX.
13. PROVIDE HANDRAILS PER IRC SEC. R311.7.8. TOP OF HANDRAIL SHALL BE 34" OR MORE THAN 38" ABOVE THE TREAD NOSINGS. HANDRAILS SHALL BE CONTINUOUS THE FULL LENGTH OF THE FLIGHT PER R311.7.8.3. THE HANDRAIL GRIP-SIZE SHALL BE PROVIDED PER R311.7.8.3.
14. PROVIDE GUARDS (MIN. 36" HEIGHT) IN LOCATIONS PER IRC SEC. R312.
15. FACTORY BUILT FIREPLACES & CHIMNEYS SHALL BE LISTED & LABELED AND SHALL BE INSTALLED & TERMINATED IN ACCORDANCE TO THE CONDITIONS OF THE LISTINGS. FACTORY BUILT FIREPLACES SHALL MEET EMISSION STANDARDS PER CH. 51-51 WAC R1004.1.1.
16. PROVIDE EXTERIOR AIR SUPPLY TO ANY FACTORY-BUILT FIREPLACE PER IRC SEC R1006.
17. WATER HEATERS SHALL COMPLY WITH THE REQUIREMENTS OF THE IRC CH. 20 AND 28.
- 17.1. UNINSTALL PER MANUFACTURERS SPECIFICATIONS, PROVIDING ALL SPECIFIED CLEARANCES & VENTILATION.
- 17.2. WATER HEATERS SHALL BE ANCHORED OR STRAPPED IN THE UPPER ONE-THIRD AND IN THE LOWER ONE-THIRD OF THE APPLIANCE.
18. ALL SHOWER AND TUB FIXTURES TO HAVE THERMOSTATIC CONTROL W/ 120° F. MAX. SETTING FOR THERMAL PROTECTION PER UPC 408.3 & 409.4.

PLAN KEY:

- INDICATES 110V SMOKE DET. PER I.R.C. 314.3 INTERCONNECTED W/ EMERGENCY BATTERY BACKUP. MAY BE COMBINED
- INDICATES CARBON MONOXIDE ALARM PER I.R.C. R315.1
- INDICATES EXHAUST VENTILATION FAN. SEE "LOCAL EXHAUST" ON COVER SHEET FOR ADDITIONAL INFORMATION.
- INDICATES SHEAR WALL PER STRUCTURAL. SEE "TYPICAL EXTERIOR WALL SHEATHING SPECIFICATIONS" ON SHEET S-0.0.
- INDICATES HOLD DOWN PER STRUCTURAL NOTES. S-0.0
- S.G. SAFETY GLASS REQUIRED PER IRC R308

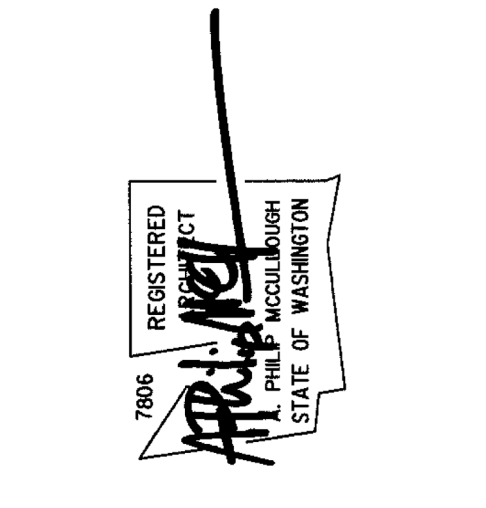
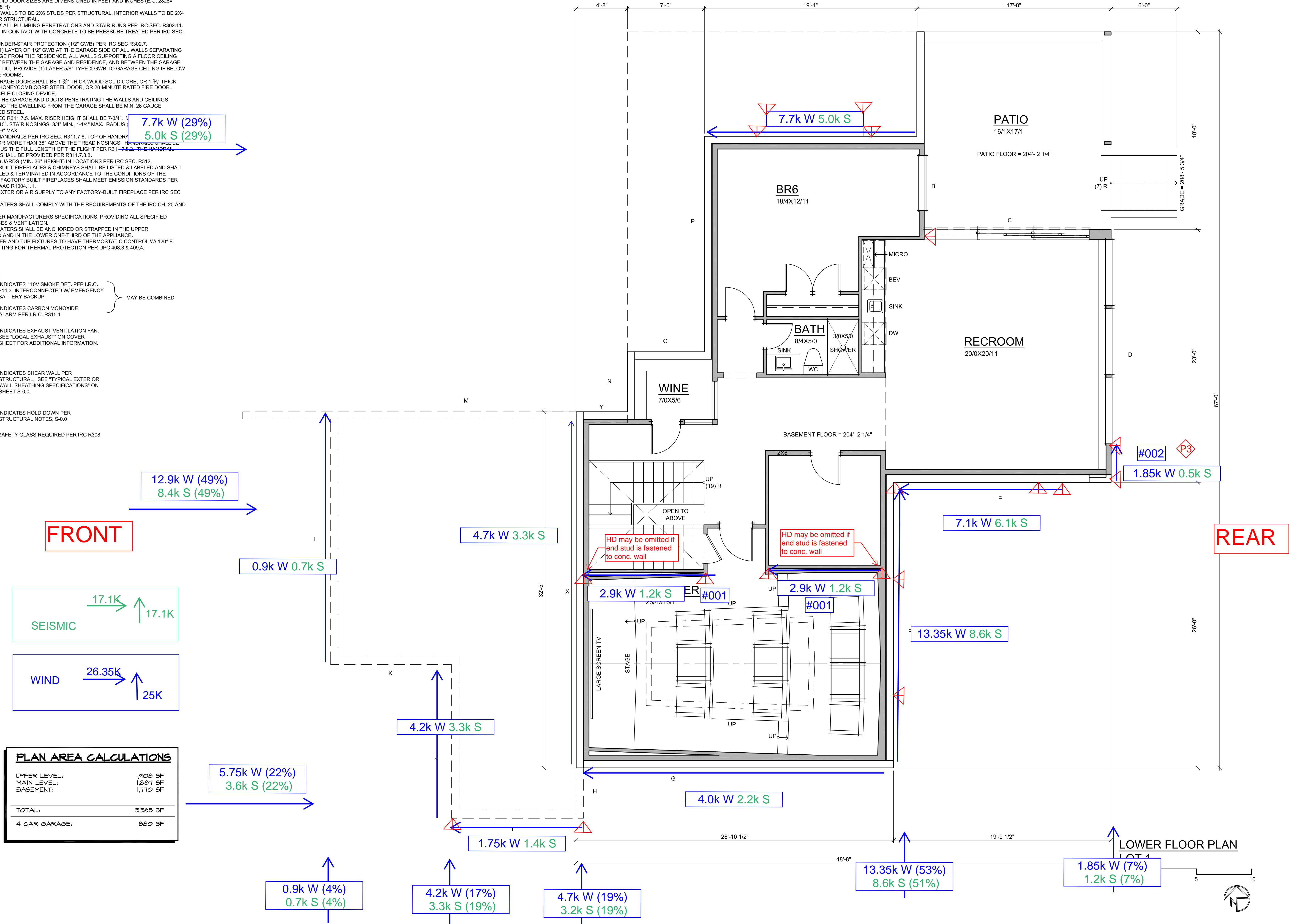

GENERAL NOTES:

- DIMENSION LINES ARE TO FACE OF STUD U.N.O.
- WINDOW SIZES & ROUGH OPENINGS TO BE VERIFIED BY CONTRACTOR.
- IF NOMINAL DOOR AND WINDOW HEIGHTS ARE SIMILAR, COORDINATE WITH DOOR AND WINDOW SPECS TO LOCATE FINAL ELEVATION OF THE HEAD HEIGHTS SO THAT ALL DOOR AND WINDOW TRIM ALIGN.
- WINDOW AND DOOR SIZES ARE DIMENSIONED IN FEET AND INCHES (E.G. 2828= 2'-8" W X 2'-8" H).
- EXTERIOR WALLS TO BE 2X6 STUDS PER STRUCTURAL, INTERIOR WALLS TO BE 2X4 STUDS PER STRUCTURAL.
- FIREBLOCK ALL PLUMBING PENETRATIONS AND STAIR RUNS PER IRC SEC. R302.11.
- ALL WOOD IN CONTACT WITH CONCRETE TO BE PRESSURE TREATED PER IRC SEC. R317.1.
- PROVIDE UNDER-STAIR PROTECTION (1/2" GWB) PER IRC SEC R302.7.
- PROVIDE (1) LAYER OF 1/2" GWB AT THE GARAGE SIDE OF ALL WALLS SEPARATING THE GARAGE FROM THE RESIDENCE, ALL WALLS SUPPORTING A FLOOR CEILING ASSEMBLY BETWEEN THE GARAGE AND RESIDENCE, AND BETWEEN THE GARAGE AND ITS ATTIC. PROVIDE (1) LAYER 5/8" TYPE X GWB TO GARAGE CEILING IF BELOW HABITABLE ROOMS.
- HOUSE/GARAGE DOOR SHALL BE 1-3/4" THICK WOOD SOLID CORE, OR 1-3/4" THICK SOLID OR HONEYCOMB CORE STEEL DOOR, OR 20-MINUTE RATED FIRE DOOR. PROVIDE SELF-CLOSING DEVICE.
- DUCTS IN THE GARAGE AND DUCTS PENETRATING THE WALLS AND CEILINGS SEPARATING THE DWELLING FROM THE GARAGE SHALL BE MIN. 26 GAUGE GALVANIZED STEEL.
- PER IRC SEC R311.7.5, MAX. RISER HEIGHT SHALL BE 7-3/4". SHALL BE 10" STAIR NOSINGS: 3/4" MIN., 1-1/4" MAX. RADIUS TREAD: 9/16" MAX.
- PROVIDE HANDRAILS PER IRC SEC. R311.7.8, TOP OF HANDRAIL SHALL BE 34" OR MORE THAN 38" ABOVE THE TREAD NOSINGS. CONTINUOUS THE FULL LENGTH OF THE FLIGHT PER R311.7.8.3. GRIP-SIZE SHALL BE PROVIDED PER R311.7.8.3.
- PROVIDE GUARDS (MIN. 36" HEIGHT) IN LOCATIONS PER IRC SEC. R312.
- FACTORY BUILT FIREPLACES & CHIMNEYS SHALL BE LISTED & LABELED AND SHALL BE INSTALLED & TERMINATED IN ACCORDANCE TO THE CONDITIONS OF THE LISTINGS. FACTORY BUILT FIREPLACES SHALL MEET EMISSION STANDARDS PER CH. 51-51 WAC R1004.1.1.
- PROVIDE EXTERIOR AIR SUPPLY TO ANY FACTORY-BUILT FIREPLACE PER IRC SEC. R1006.
- WATER HEATERS SHALL COMPLY WITH THE REQUIREMENTS OF THE IRC CH. 20 AND 28.
- INSTALL PER MANUFACTURERS SPECIFICATIONS, PROVIDING ALL SPECIFIED CLEARANCES & VENTILATION.
- WATER HEATERS SHALL BE ANCHORED OR STRAPPED IN THE UPPER ONE-THIRD AND IN THE LOWER ONE-THIRD OF THE APPLIANCE.
- ALL SHOWER AND TUB FIXTURES TO HAVE THERMOSTATIC CONTROL W/ 120° F. MAX. SETTING FOR THERMAL PROTECTION PER UPC 408.3 & 409.4.

PLAN KEY:

- INDICATES 110V SMOKE DET. PER I.R.C. 314.3 INTERCONNECTED W/ EMERGENCY BATTERY BACKUP. MAY BE COMBINED
- INDICATES CARBON MONOXIDE ALARM PER I.R.C. R315.1
- INDICATES EXHAUST VENTILATION FAN. SEE "LOCAL EXHAUST" ON COVER SHEET FOR ADDITIONAL INFORMATION.
- INDICATES SHEAR WALL PER STRUCTURAL. SEE "TYPICAL EXTERIOR WALL SHEATHING SPECIFICATIONS" ON SHEET S-0.0.
- INDICATES HOLD DOWN PER STRUCTURAL NOTES. S-0.0
- SAFETY GLASS REQUIRED PER IRC R308

6.8k W (31%)
4.6k S (31%)

#105 & #106 have 514 plf (514 *336/630=274 plf) (427 plf (427*239/451=226 plf)) and 275 plf (224 plf) respectively. It is our professional opinion this is within an acceptable tolerance to be considered proportional

8.35k W (47%)
6.9k S (47%)

#101 & #102 have 139 plf (116 plf) and 146 plf (117 plf) respectively. It is our professional opinion this is within an acceptable tolerance to be considered proportional

3.9k W (22%)
3.2k S (22%)

PLAN AREA CALCULATIONS

UPPER LEVEL:	1,908 SF
MAIN LEVEL:	1,087 SF
BASEMENT:	1,770 SF
TOTAL:	5,565 SF
4 CAR GARAGE:	880 SF

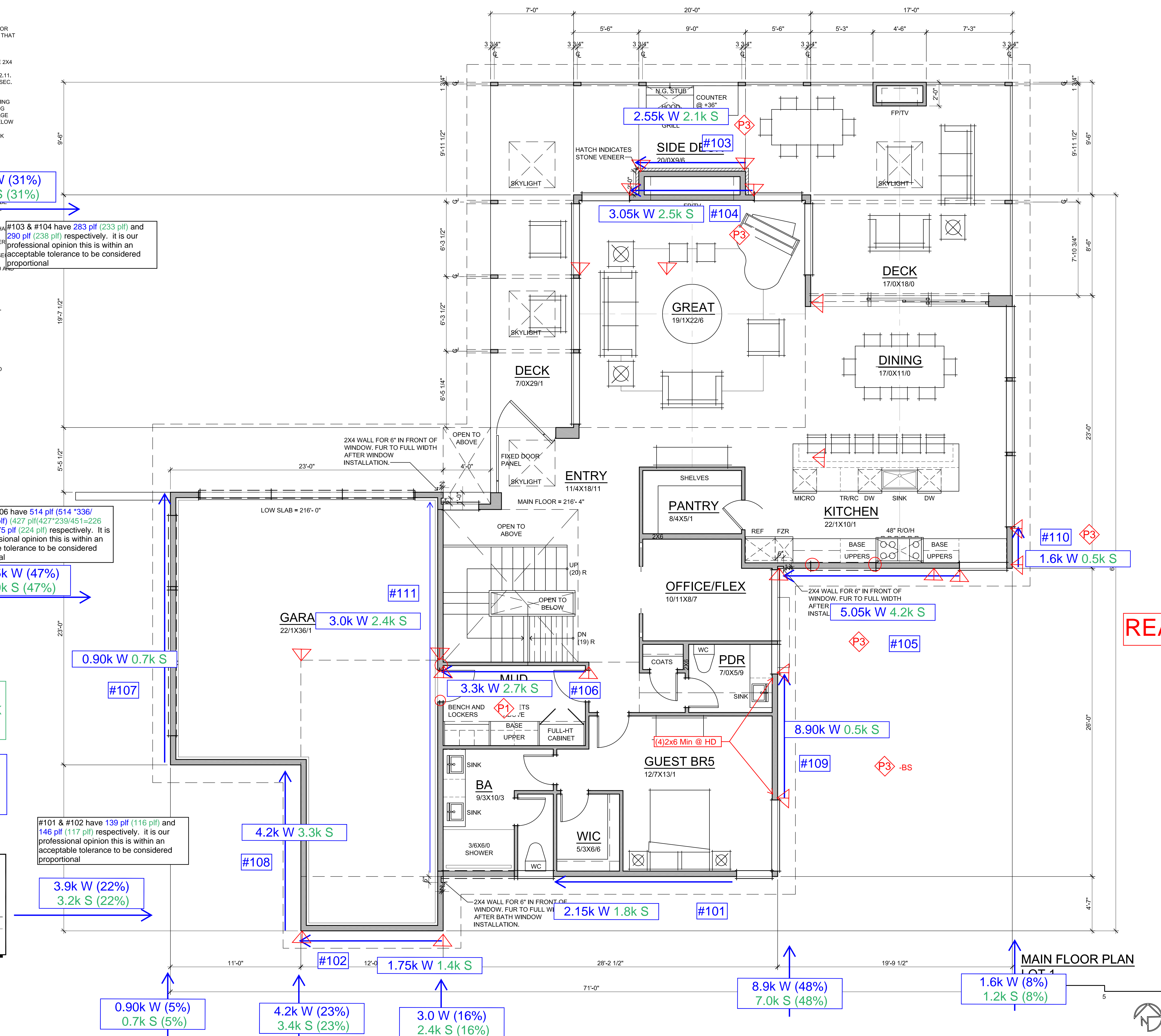

SEISMIC 14.7K ↑ 14.7K

WIND 17.85K → 18.6K ↑

FRONT

REAR

MAIN FLOOR PLAN

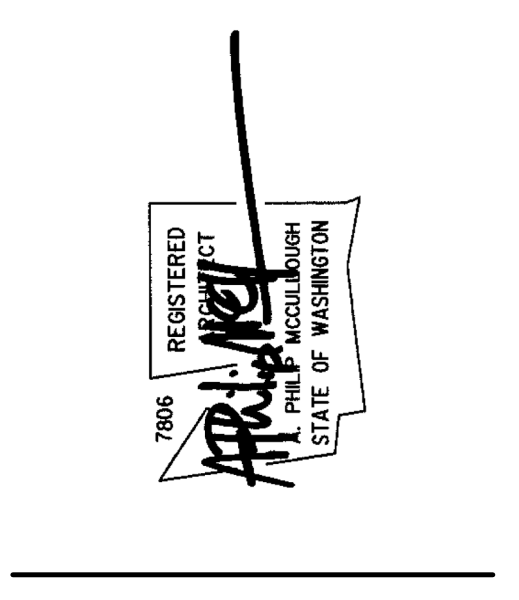

LOT 1
7216 93rd AVE. SE
MERCER ISLAND, WA 98040

GENERAL NOTES:

- DIMENSION LINES ARE TO FACE OF STUD U.N.O.
- WINDOW SIZES & ROUGH OPENINGS TO BE VERIFIED BY CONTRACTOR.
- IF NOMINAL DOOR AND WINDOW HEIGHTS ARE SIMILAR, COORDINATE WITH DOOR AND WINDOW SPEC'S TO LOCATE FINAL ELEVATION OF THE HEAD HEIGHTS SO THAT ALL DOOR AND WINDOW TRIM ALIGN.
- WINDOW AND DOOR SIZES ARE DIMENSIONED IN FEET AND INCHES (E.G. 2828= 2'-8" W X 2'-8" H)
- EXTERIOR WALLS TO BE 2X6 STUDS PER STRUCTURAL, INTERIOR WALLS TO BE 2X4 STUDS PER STRUCTURAL.
- FIREBLOCK ALL PLUMBING PENETRATIONS AND STAIR RUNS PER IRC SEC. R302.11.
- ALL WOOD IN CONTACT WITH CONCRETE TO BE PRESSURE TREATED PER IRC SEC. R317.1.
- PROVIDE UNDER-STAIR PROTECTION (1/2" GWB) PER IRC SEC R302.7.
- PROVIDE (1) LAYER OF 1/2" GWB AT THE GARAGE SIDE OF ALL WALLS SEPARATING THE GARAGE FROM THE RESIDENCE, ALL WALLS SUPPORTING A FLOOR CEILING ASSEMBLY BETWEEN THE GARAGE AND RESIDENCE, AND BETWEEN THE GARAGE AND ITS ATTIC. PROVIDE (1) LAYER 5/8" TYPE X GWB TO GARAGE CEILING IF BELOW HABITABLE ROOMS.
- HOUSE/GARAGE DOOR SHALL BE 1-3/4" THICK WOOD SOLID CORE, OR 1-3/4" THICK SOLID OR HONEYCOMB CORE STEEL DOOR, OR 20-MINUTE RATED FIRE DOOR, PROVIDE SELF-CLOSING DEVICE.
- DUCTS IN THE GARAGE AND DUCTS PENETRATING THE WALLS AND CEILINGS SEPARATING THE DWELLING FROM THE GARAGE SHALL BE MIN. 26 GAUGE GALVANIZED STEEL.
- PER IRC SEC R311.7.5, MAX. RISER HEIGHT SHALL BE 7-3/4". MIN. TREAD DEPTH SHALL BE 10". STAIR NOSINGS: 3/4" MIN., 1-1/4" MAX. RADIUS @ LEADING EDGE OF TREAD: 9/16" MAX.
- PROVIDE HANDRAILS PER IRC SEC. R311.7.8, TOP OF HANDRAIL SHALL BE NOT LESS THAN 34" OR MORE THAN 38" ABOVE THE TREAD NOSINGS. HANDRAILS SHALL BE CONTINUOUS THE FULL LENGTH OF THE FLIGHT PER R311.7.8.2. THE HANDRAIL GRIP-SIZE SHALL BE PROVIDED PER R311.7.8.3.
- PROVIDE GUARDS (MIN. 36" HEIGHT) IN LOCATIONS PER IRC SEC. R312.
- FACTORY BUILT FIREPLACES & CHIMNEYS SHALL BE LISTED & LABELED AND SHALL BE INSTALLED & TERMINATED IN ACCORDANCE TO THE CONDITIONS OF THE LISTINGS. FACTORY BUILT FIREPLACES SHALL MEET EMISSION STANDARDS PER CH. 51-51 WAC R1004.1.1.
- PROVIDE EXTERIOR AIR SUPPLY TO ANY FACTORY-BUILT FIREPLACE PER IRC SEC R1006.
- WATER HEATERS SHALL COMPLY WITH THE REQUIREMENTS OF THE IRC CH. 20 AND 28.
- UNINSTALL PER MANUFACTURERS SPECIFICATIONS, PROVIDING ALL SPECIFIED CLEARANCES & VENTILATION.
- WATER HEATERS SHALL BE ANCHORED OR STRAPPED IN THE UPPER ONE-THIRD AND IN THE LOWER ONE-THIRD OF THE APPLIANCE.
- ALL SHOWER AND TUB FIXTURES TO HAVE THERMOSTATIC CONTROL W/ 120° F. MAX. SETTING FOR THERMAL PROTECTION PER UPC 408.3 & 409.4.

PLAN KEY:

- INDICATES 110V SMOKE DET. PER I.R.C. 314.3 INTERCONNECTED W/ EMERGENCY BATTERY BACKUP. MAY BE COMBINED
- INDICATES CARBON MONOXIDE ALARM PER I.R.C. R315.1
- INDICATES EXHAUST VENTILATION FAN. SEE "LOCAL EXHAUST" ON COVER SHEET FOR ADDITIONAL INFORMATION.
- INDICATES SHEAR WALL PER STRUCTURAL (SEE "TYPICAL EXTERIOR WALL SHEATHING SPECIFICATIONS" ON SHEET S-0.0.)
- INDICATES HOLD DOWN PER STRUCTURAL NOTES. S-0.0
- SAFETY GLASS REQUIRED PER IRC R308

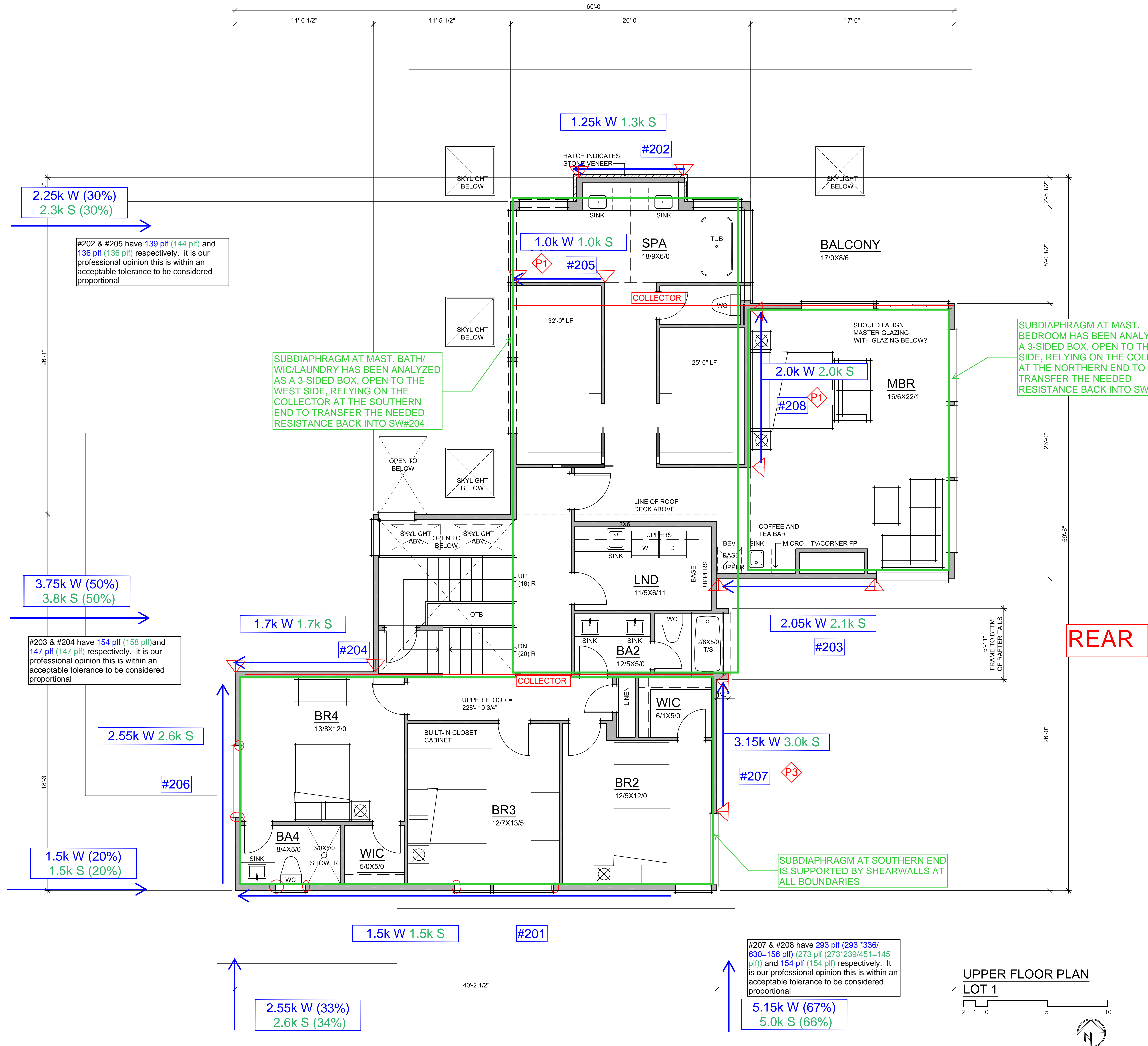

PLAN AREA CALCULATIONS

UPPER LEVEL:	1,908 SF
MAIN LEVEL:	1,087 SF
BASEMENT:	1,770 SF
TOTAL:	5,565 SF
4 CAR GARAGE:	880 SF

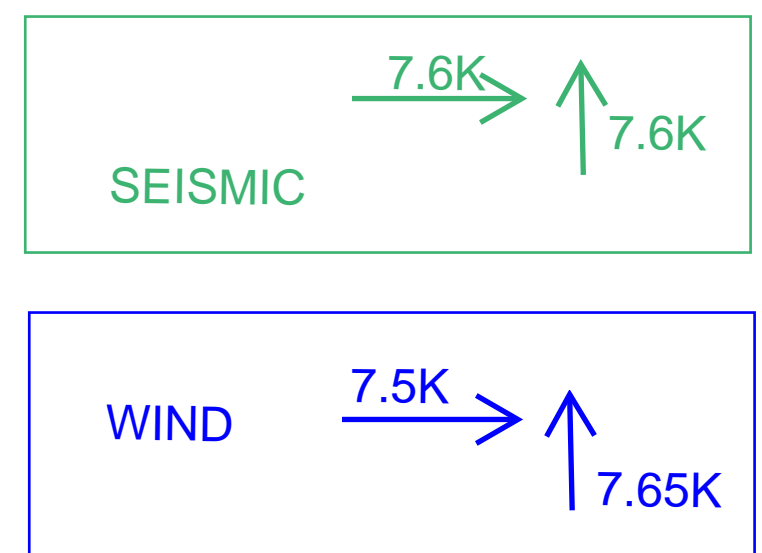

Revisions

Revisions	Comment

Date: 2020.11.23
 Job No: 19-034
 Project No: 00000
 Drawn: MCG
 Approved: APM
 Owner: Barcelo homes

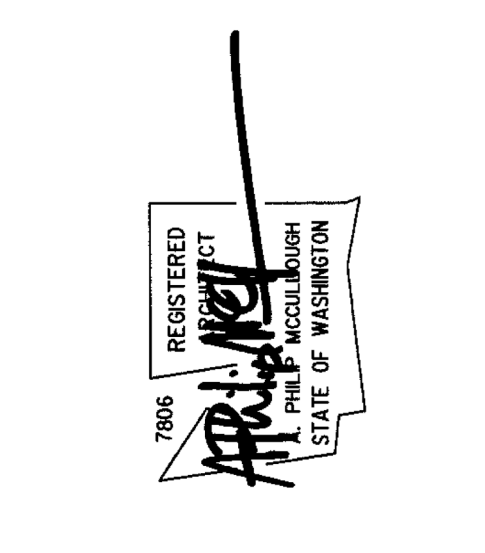

LOT 1
 7216 93rd AVE. SE
 MERCER ISLAND, WA 98040



SHEARWALL DESIGN SUMMARY

SHEARWALL 201: 2ND - SIDE EXT. WALL @ BED 2 TO BED 4

SHEARWALL PROPERTIES:

WALL HEIGHT, H FT. MAX WALL OPENING HT, H_c FT.
WALL LENGTH, L FT. QUALIFYING WALL LENGTH, L FT. SHEARWALL ASSEMBLY

CAPACITY EVALUATION:

TOTAL SHEAR LOAD ON WALL LBS < ALLOWABLE SHEARWALL CAPACITY LBS

SHEARWALL ASSEMBLY SPECIFICATION

P1 - 1-SIDE 7/16" OSB
FASTENED W/ 8D NAILS AT 6"O.C. PANEL EDGES & 12"O.C. PANEL FIELD - EDGES BLOCKED
ADEQUATE

OVERTURNING EVALUATION:

RESISTIVE DL PLF OVERTURNING MOMENT K-FT HOLD DOWN DESIGN LOAD LBS
DL AT ENDS OF WALL LBS RESISTIVE MOMENT K-FT HOLDDOWN CAPACITY LBS

HOLD-DOWN SPECIFICATION

NO HOLDDOWN REQUIRED

SHEARWALL 202: 2ND - SIDE EXT. WALL @ MASTER BATH

SHEARWALL PROPERTIES:

WALL HEIGHT, H FT. MAX WALL OPENING HT, H_c FT.
WALL LENGTH, L FT. QUALIFYING WALL LENGTH, L FT. SHEARWALL ASSEMBLY

CAPACITY EVALUATION:

TOTAL SHEAR LOAD ON WALL LBS < ALLOWABLE SHEARWALL CAPACITY LBS

SHEARWALL ASSEMBLY SPECIFICATION

P1 - 1-SIDE 7/16" OSB
FASTENED W/ 8D NAILS AT 6"O.C. PANEL EDGES & 12"O.C. PANEL FIELD - EDGES BLOCKED
ADEQUATE

OVERTURNING EVALUATION:

RESISTIVE DL PLF OVERTURNING MOMENT K-FT HOLD DOWN DESIGN LOAD LBS
DL AT ENDS OF WALL LBS RESISTIVE MOMENT K-FT HOLDDOWN CAPACITY LBS

HOLD-DOWN SPECIFICATION

SIMPSON CS 16 STRAP TIE (14" END LENGTH)



SHEARWALL DESIGN SUMMARY

SHEARWALL 203: 2ND - SIDE EXT. WALL @ MASTER BED

SHEARWALL PROPERTIES:

WALL HEIGHT, H FT. MAX WALL OPENING HT, H_c FT.
WALL LENGTH, L FT. QUALIFYING WALL LENGTH, L FT. SHEARWALL ASSEMBLY

CAPACITY EVALUATION:

TOTAL SHEAR LOAD ON WALL LBS < ALLOWABLE SHEARWALL CAPACITY LBS

SHEARWALL ASSEMBLY SPECIFICATION

P1 - 1-SIDE 7/16" OSB
FASTENED W/ 8D NAILS AT 6"D.C. PANEL EDGES & 12"D.C. PANEL FIELD - EDGES BLOCKED
ADEQUATE

OVERTURNING EVALUATION:

RESISTIVE DL PLF OVERTURNING MOMENT K-FT UPLIFT CONNECTOR DESIGN LOAD LBS
DL AT ENDS OF WALL LBS RESISTIVE MOMENT K-FT HOLDOWN CAPACITY LBS

HOLD-DOWN SPECIFICATION

NO HOLDOWN REQUIRED

SHEARWALL 204: 2ND - SIDE EXT. WALL @ BED 4

SHEARWALL PROPERTIES:

WALL HEIGHT, H FT. MAX WALL OPENING HT, H_c FT.
WALL LENGTH, L FT. QUALIFYING WALL LENGTH, L FT. SHEARWALL ASSEMBLY

CAPACITY EVALUATION:

TOTAL SHEAR LOAD ON WALL LBS < ALLOWABLE SHEARWALL CAPACITY LBS

SHEARWALL ASSEMBLY SPECIFICATION

P1 - 1-SIDE 7/16" OSB
FASTENED W/ 8D NAILS AT 6"D.C. PANEL EDGES & 12"D.C. PANEL FIELD - EDGES BLOCKED
ADEQUATE

OVERTURNING EVALUATION:

RESISTIVE DL PLF OVERTURNING MOMENT K-FT HOLD DOWN DESIGN LOAD LBS
DL AT ENDS OF WALL LBS RESISTIVE MOMENT K-FT HOLDOWN CAPACITY LBS

HOLD-DOWN SPECIFICATION

NO HOLDOWN REQUIRED



SHEARWALL DESIGN SUMMARY

SHEARWALL 205: 2ND - SIDE INT. WALL @ SPA

SHEARWALL PROPERTIES:

WALL HEIGHT, H FT. MAX WALL OPENING HT, H_c FT.
WALL LENGTH, L FT. QUALIFYING WALL LENGTH, L FT. SHEARWALL ASSEMBLY

CAPACITY EVALUATION:

TOTAL SHEAR LOAD ON WALL LBS < ALLOWABLE SHEARWALL CAPACITY LBS

SHEARWALL ASSEMBLY SPECIFICATION

P1 - 1-SIDE 7/16" OSB
FASTENED W/ 8D NAILS AT 6"O.C. PANEL EDGES & 12"O.C. PANEL FIELD - EDGES BLOCKED
ADEQUATE

OVERTURNING EVALUATION:

RESISTIVE DL PLF OVERTURNING MOMENT K-FT UPLIFT CONNECTOR DESIGN LOAD LBS
DL AT ENDS OF WALL LBS RESISTIVE MOMENT K-FT HOLDOWN CAPACITY LBS

HOLD-DOWN SPECIFICATION

SIMPSON CS 16 STRAP TIE (14" END LENGTH)

SHEARWALL 206: 2ND - FRONT EXT. WALL @ BED 4

SHEARWALL PROPERTIES:

WALL HEIGHT, H FT. MAX WALL OPENING HT, H_c FT.
WALL LENGTH, L FT. QUALIFYING WALL LENGTH, L FT. SHEARWALL ASSEMBLY

CAPACITY EVALUATION:

TOTAL SHEAR LOAD ON WALL LBS < ALLOWABLE SHEARWALL CAPACITY LBS

SHEARWALL ASSEMBLY SPECIFICATION

P1 - 1-SIDE 7/16" OSB
FASTENED W/ 8D NAILS AT 6"O.C. PANEL EDGES & 12"O.C. PANEL FIELD - EDGES BLOCKED
ADEQUATE

OVERTURNING EVALUATION:

RESISTIVE DL PLF OVERTURNING MOMENT K-FT HOLD DOWN DESIGN LOAD LBS
DL AT ENDS OF WALL LBS RESISTIVE MOMENT K-FT HOLDOWN CAPACITY LBS

HOLD-DOWN SPECIFICATION

NO HOLDOWN REQUIRED



SHEARWALL DESIGN SUMMARY

SHEARWALL 207: 2ND - REAR EXT. WALL @ BED 2

SHEARWALL PROPERTIES:

WALL HEIGHT, H FT. MAX WALL OPENING HT, H_c FT.
WALL LENGTH, L FT. QUALIFYING WALL LENGTH, L FT. SHEARWALL ASSEMBLY

CAPACITY EVALUATION:

TOTAL SHEAR LOAD ON WALL LBS < ALLOWABLE SHEARWALL CAPACITY LBS

SHEARWALL ASSEMBLY SPECIFICATION

P3 - 1-SIDE 7/16" OSB
FASTENED W/ 8D NAILS AT 3"D.C. PANEL EDGES & 12"D.C. PANEL FIELD - EDGES BLOCKED
ADEQUATE

OVERTURNING EVALUATION:

RESISTIVE DL PLF OVERTURNING MOMENT K-FT UPLIFT CONNECTOR DESIGN LOAD LBS
DL AT ENDS OF WALL LBS RESISTIVE MOMENT K-FT HOLDOWN CAPACITY LBS

HOLD-DOWN SPECIFICATION

SIMPSON CS 16 STRAP TIE (14" END LENGTH)

SHEARWALL 208: 2ND - REAR INT WALL @ MASTER BED

SHEARWALL PROPERTIES:

WALL HEIGHT, H FT. MAX WALL OPENING HT, H_c FT.
WALL LENGTH, L FT. QUALIFYING WALL LENGTH, L FT. SHEARWALL ASSEMBLY

CAPACITY EVALUATION:

TOTAL SHEAR LOAD ON WALL LBS < ALLOWABLE SHEARWALL CAPACITY LBS

SHEARWALL ASSEMBLY SPECIFICATION

P1 - 1-SIDE 7/16" OSB
FASTENED W/ 8D NAILS AT 6"D.C. PANEL EDGES & 12"D.C. PANEL FIELD - EDGES BLOCKED
ADEQUATE

OVERTURNING EVALUATION:

RESISTIVE DL PLF OVERTURNING MOMENT K-FT HOLD DOWN DESIGN LOAD LBS
DL AT ENDS OF WALL LBS RESISTIVE MOMENT K-FT HOLDOWN CAPACITY LBS

HOLD-DOWN SPECIFICATION

SIMPSON CS 16 STRAP TIE (14" END LENGTH)



SHEARWALL DESIGN SUMMARY

SHEARWALL XXX: - NOT USED

SHEARWALL PROPERTIES:

WALL HEIGHT, H FT. MAX WALL OPENING HT, H_c FT.
WALL LENGTH, L FT. QUALIFYING WALL LENGTH, L FT. SHEARWALL ASSEMBLY

CAPACITY EVALUATION:

TOTAL SHEAR LOAD ON WALL LBS ALLOWABLE SHEARWALL CAPACITY LBS
###

SHEARWALL ASSEMBLY SPECIFICATION

P1 - 1-SIDE 7/16" OSB
FASTENED W/ 8D NAILS AT 6"O.C. PANEL EDGES & 12"O.C. PANEL FIELD - EDGES BLOCKED
#DIV/0!

OVERTURNING EVALUATION:

RESISTIVE DL PLF OVERTURNING MOMENT K-FT UPLIFT CONNECTOR DESIGN LOAD LBS
DL AT ENDS OF WALL LBS RESISTIVE MOMENT K-FT HOLDOWN CAPACITY LBS

HOLD-DOWN SPECIFICATION

NO HOLDOWN REQUIRED

SHEARWALL XXX: - NOT USED

SHEARWALL PROPERTIES:

WALL HEIGHT, H FT. MAX WALL OPENING HT, H_c FT.
WALL LENGTH, L FT. QUALIFYING WALL LENGTH, L FT. SHEARWALL ASSEMBLY

CAPACITY EVALUATION:

TOTAL SHEAR LOAD ON WALL LBS ALLOWABLE SHEARWALL CAPACITY LBS
###

SHEARWALL ASSEMBLY SPECIFICATION

P1 - 1-SIDE 7/16" OSB
FASTENED W/ 8D NAILS AT 6"O.C. PANEL EDGES & 12"O.C. PANEL FIELD - EDGES BLOCKED
#DIV/0!

OVERTURNING EVALUATION:

RESISTIVE DL PLF OVERTURNING MOMENT K-FT HOLD DOWN DESIGN LOAD LBS
DL AT ENDS OF WALL LBS RESISTIVE MOMENT K-FT HOLDOWN CAPACITY LBS

HOLD-DOWN SPECIFICATION

NO HOLDOWN REQUIRED



SHEARWALL DESIGN SUMMARY

SHEARWALL 101: 1ST - SIDE EXT. WALL @ GUEST

SHEARWALL PROPERTIES:

WALL HEIGHT, H FT. MAX WALL OPENING HT, H_c FT.
WALL LENGTH, L FT. QUALIFYING WALL LENGTH, L FT. SHEARWALL ASSEMBLY

CAPACITY EVALUATION:

TOTAL SHEAR LOAD ON WALL LBS < ALLOWABLE SHEARWALL CAPACITY LBS

SHEARWALL ASSEMBLY SPECIFICATION

P1 - 1-SIDE 7/16" OSB
FASTENED W/ 8D NAILS AT 6"D.C. PANEL EDGES & 12"D.C. PANEL FIELD - EDGES BLOCKED
ADEQUATE

OVERTURNING EVALUATION:

RESISTIVE DL PLF OVERTURNING MOMENT K-FT UPLIFT CONNECTOR DESIGN LOAD LBS
DL AT ENDS OF WALL LBS RESISTIVE MOMENT K-FT HOLDOWN CAPACITY LBS

HOLD-DOWN SPECIFICATION

NO HOLDOWN REQUIRED

SHEARWALL 102: 1ST - SIDE EXT. WALL @ GARAGE

SHEARWALL PROPERTIES:

WALL HEIGHT, H FT. MAX WALL OPENING HT, H_c FT.
WALL LENGTH, L FT. QUALIFYING WALL LENGTH, L FT. SHEARWALL ASSEMBLY

CAPACITY EVALUATION:

TOTAL SHEAR LOAD ON WALL LBS < ALLOWABLE SHEARWALL CAPACITY LBS

SHEARWALL ASSEMBLY SPECIFICATION

P1 - 1-SIDE 7/16" OSB
FASTENED W/ 8D NAILS AT 6"D.C. PANEL EDGES & 12"D.C. PANEL FIELD - EDGES BLOCKED
ADEQUATE

OVERTURNING EVALUATION:

RESISTIVE DL PLF OVERTURNING MOMENT K-FT HOLD DOWN DESIGN LOAD LBS
DL AT ENDS OF WALL LBS RESISTIVE MOMENT K-FT HOLDOWN CAPACITY LBS

HOLD-DOWN SPECIFICATION

SIMPSON STHD14RJ HOLDOWN



SHEARWALL DESIGN SUMMARY

SHEARWALL 103: 1ST - SIDE EXT. WALL @ FIREPLACE

SHEARWALL PROPERTIES:

WALL HEIGHT, H	<input type="text" value="11.5"/>	FT.	MAX WALL OPENING HT, H _c	<input type="text" value="0.0"/>	FT.		
WALL LENGTH, L	<input type="text" value="9.0"/>	FT.	QUALIFYING WALL LENGTH, L	<input type="text" value="9.0"/>	FT.	SHEARWALL ASSEMBLY	<input type="text" value="P3"/>

CAPACITY EVALUATION:

TOTAL SHEAR LOAD ON WALL	<input type="text" value="2550"/>	LBS	<	ALLOWABLE SHEARWALL CAPACITY	<input type="text" value="5670"/>	LBS
--------------------------	-----------------------------------	-----	---	------------------------------	-----------------------------------	-----

SHEARWALL ASSEMBLY SPECIFICATION

P3 - 1-SIDE 7/16" OSB
FASTENED W/ 8D NAILS AT 3"O.C. PANEL EDGES & 12"O.C. PANEL FIELD - EDGES BLOCKED
ADEQUATE

OVERTURNING EVALUATION:

RESISTIVE DL	<input type="text" value="311"/>	PLF	OVERTURNING MOMENT	<input type="text" value="36.4"/>	K-FT	UPLIFT CONNECTOR DESIGN LOAD	<input type="text" value="2723"/>	LBS
DL AT ENDS OF WALL	<input type="text" value="800"/>	LBS	RESISTIVE MOMENT	<input type="text" value="11.9"/>	K-FT	HOLDOWN CAPACITY	<input type="text" value="4645"/>	LBS

HOLD-DOWN SPECIFICATION

SIMPSON MSTC66 STRAP TIE (20" END LENGTH)

SHEARWALL 104: 1ST - SIDE EXT. WALL @ GREAT ROOM

SHEARWALL PROPERTIES:

WALL HEIGHT, H	<input type="text" value="11.5"/>	FT.	MAX WALL OPENING HT, H _c	<input type="text" value="0.0"/>	FT.		
WALL LENGTH, L	<input type="text" value="10.5"/>	FT.	QUALIFYING WALL LENGTH, L	<input type="text" value="10.5"/>	FT.	SHEARWALL ASSEMBLY	<input type="text" value="P3"/>

CAPACITY EVALUATION:

TOTAL SHEAR LOAD ON WALL	<input type="text" value="3050"/>	LBS	<	ALLOWABLE SHEARWALL CAPACITY	<input type="text" value="6615"/>	LBS
--------------------------	-----------------------------------	-----	---	------------------------------	-----------------------------------	-----

SHEARWALL ASSEMBLY SPECIFICATION

P3 - 1-SIDE 7/16" OSB
FASTENED W/ 8D NAILS AT 3"O.C. PANEL EDGES & 12"O.C. PANEL FIELD - EDGES BLOCKED
ADEQUATE

OVERTURNING EVALUATION:

RESISTIVE DL	<input type="text" value="287"/>	PLF	OVERTURNING MOMENT	<input type="text" value="35.1"/>	K-FT	HOLD DOWN DESIGN LOAD	<input type="text" value="2196"/>	LBS
DL AT ENDS OF WALL	<input type="text" value="400"/>	LBS	RESISTIVE MOMENT	<input type="text" value="12.0"/>	K-FT	HOLDOWN CAPACITY	<input type="text" value="4935"/>	LBS

HOLD-DOWN SPECIFICATION

SIMPSON STHD14RJ HOLDOWN



SHEARWALL DESIGN SUMMARY

SHEARWALL 105: 1ST - SIDE EXT. WALL @ KITCHEN

SHEARWALL PROPERTIES:

WALL HEIGHT, H FT. MAX WALL OPENING HT, H_c FT.
WALL LENGTH, L FT. QUALIFYING WALL LENGTH, L FT. SHEARWALL ASSEMBLY

CAPACITY EVALUATION:

TOTAL SHEAR LOAD ON WALL LBS < ALLOWABLE SHEARWALL CAPACITY LBS

SHEARWALL ASSEMBLY SPECIFICATION

P3 - 1-SIDE 7/16" OSB
FASTENED W/ 8D NAILS AT 3"D.C. PANEL EDGES & 12"D.C. PANEL FIELD - EDGES BLOCKED
ADEQUATE

OVERTURNING EVALUATION:

RESISTIVE DL PLF OVERTURNING MOMENT K-FT UPLIFT CONNECTOR DESIGN LOAD LBS
DL AT ENDS OF WALL LBS RESISTIVE MOMENT K-FT HOLDOWN CAPACITY LBS

HOLD-DOWN SPECIFICATION

SIMPSON STDH14RJ HOLDOWN

SHEARWALL 106: 1ST - SIDE INT. WALL @ MUD

SHEARWALL PROPERTIES:

WALL HEIGHT, H FT. MAX WALL OPENING HT, H_c FT.
WALL LENGTH, L FT. QUALIFYING WALL LENGTH, L FT. SHEARWALL ASSEMBLY

CAPACITY EVALUATION:

TOTAL SHEAR LOAD ON WALL LBS < ALLOWABLE SHEARWALL CAPACITY LBS

SHEARWALL ASSEMBLY SPECIFICATION

P1 - 1-SIDE 7/16" OSB
FASTENED W/ 8D NAILS AT 6"D.C. PANEL EDGES & 12"D.C. PANEL FIELD - EDGES BLOCKED
ADEQUATE

OVERTURNING EVALUATION:

RESISTIVE DL PLF OVERTURNING MOMENT K-FT HOLD DOWN DESIGN LOAD LBS
DL AT ENDS OF WALL LBS RESISTIVE MOMENT K-FT HOLDOWN CAPACITY LBS

HOLD-DOWN SPECIFICATION

SIMPSON MSTC66 STRAP TIE (20" END LENGTH)



SHEARWALL DESIGN SUMMARY

SHEARWALL 107: 1ST - FRONT EXT. WALL @ GARAGE (LEFT)

SHEARWALL PROPERTIES:

WALL HEIGHT, H FT. MAX WALL OPENING HT, H_c FT.
WALL LENGTH, L FT. QUALIFYING WALL LENGTH, L FT. SHEARWALL ASSEMBLY

CAPACITY EVALUATION:

TOTAL SHEAR LOAD ON WALL LBS < ALLOWABLE SHEARWALL CAPACITY LBS

SHEARWALL ASSEMBLY SPECIFICATION

P1 - 1-SIDE 7/16" OSB
FASTENED W/ 8D NAILS AT 6"O.C. PANEL EDGES & 12"O.C. PANEL FIELD - EDGES BLOCKED
ADEQUATE

OVERTURNING EVALUATION:

RESISTIVE DL PLF OVERTURNING MOMENT K-FT UPLIFT CONNECTOR DESIGN LOAD LBS
DL AT ENDS OF WALL LBS RESISTIVE MOMENT K-FT HOLDOWN CAPACITY LBS

HOLD-DOWN SPECIFICATION

NO HOLDOWN REQUIRED

SHEARWALL 108: 1ST - FRONT EXT. WALL @ GARAGE (RIGHT)

SHEARWALL PROPERTIES:

WALL HEIGHT, H FT. MAX WALL OPENING HT, H_c FT.
WALL LENGTH, L FT. QUALIFYING WALL LENGTH, L FT. SHEARWALL ASSEMBLY

CAPACITY EVALUATION:

TOTAL SHEAR LOAD ON WALL LBS < ALLOWABLE SHEARWALL CAPACITY LBS

SHEARWALL ASSEMBLY SPECIFICATION

P1 - 1-SIDE 7/16" OSB
FASTENED W/ 8D NAILS AT 6"O.C. PANEL EDGES & 12"O.C. PANEL FIELD - EDGES BLOCKED
ADEQUATE

OVERTURNING EVALUATION:

RESISTIVE DL PLF OVERTURNING MOMENT K-FT HOLD DOWN DESIGN LOAD LBS
DL AT ENDS OF WALL LBS RESISTIVE MOMENT K-FT HOLDOWN CAPACITY LBS

HOLD-DOWN SPECIFICATION

SIMPSON STHD14RJ HOLDOWN



SHEARWALL DESIGN SUMMARY

SHEARWALL 109: 1ST - REAR EXT. WALL @ GUEST

SHEARWALL PROPERTIES:

WALL HEIGHT, H FT. MAX WALL OPENING HT, H_c FT.
WALL LENGTH, L FT. QUALIFYING WALL LENGTH, L FT. SHEARWALL ASSEMBLY

CAPACITY EVALUATION:

TOTAL SHEAR LOAD ON WALL LBS < ALLOWABLE SHEARWALL CAPACITY LBS

SHEARWALL ASSEMBLY SPECIFICATION

P3-BS - 2-SIDES 7/16" OSB
FASTENED W/ 8D NAILS AT 3"D.C. PANEL EDGES & 12"D.C. PANEL FIELD - EDGES BLOCKED
ADEQUATE

OVERTURNING EVALUATION:

RESISTIVE DL PLF OVERTURNING MOMENT K-FT UPLIFT CONNECTOR DESIGN LOAD LBS
DL AT ENDS OF WALL LBS RESISTIVE MOMENT K-FT HOLDOWN CAPACITY LBS

HOLD-DOWN SPECIFICATION

SIMPSON HDU14-SDS2.5 HOLDOWN

SHEARWALL 110: 1ST - REAR EXT. WALL @ KITCHEN

SHEARWALL PROPERTIES:

WALL HEIGHT, H FT. MAX WALL OPENING HT, H_c FT.
WALL LENGTH, L FT. QUALIFYING WALL LENGTH, L FT. SHEARWALL ASSEMBLY

CAPACITY EVALUATION:

TOTAL SHEAR LOAD ON WALL LBS < ALLOWABLE SHEARWALL CAPACITY LBS

SHEARWALL ASSEMBLY SPECIFICATION

P3 - 1-SIDE 7/16" OSB
FASTENED W/ 8D NAILS AT 3"D.C. PANEL EDGES & 12"D.C. PANEL FIELD - EDGES BLOCKED
ADEQUATE

OVERTURNING EVALUATION:

RESISTIVE DL PLF OVERTURNING MOMENT K-FT HOLD DOWN DESIGN LOAD LBS
DL AT ENDS OF WALL LBS RESISTIVE MOMENT K-FT HOLDOWN CAPACITY LBS

HOLD-DOWN SPECIFICATION

SIMPSON MSTC78 STRAP TIE



SHEARWALL DESIGN SUMMARY

SHEARWALL 111: 1ST - FRONT INT. WALL @ GARAGE

SHEARWALL PROPERTIES:

WALL HEIGHT, H FT. MAX WALL OPENING HT, H_c FT.
WALL LENGTH, L FT. QUALIFYING WALL LENGTH, L FT. SHEARWALL ASSEMBLY

CAPACITY EVALUATION:

TOTAL SHEAR LOAD ON WALL LBS < ALLOWABLE SHEARWALL CAPACITY LBS

SHEARWALL ASSEMBLY SPECIFICATION

P1 - 1-SIDE 7/16" OSB
FASTENED W/ 8D NAILS AT 6"O.C. PANEL EDGES & 12"O.C. PANEL FIELD - EDGES BLOCKED
ADEQUATE

OVERTURNING EVALUATION:

RESISTIVE DL PLF OVERTURNING MOMENT K-FT UPLIFT CONNECTOR DESIGN LOAD LBS
DL AT ENDS OF WALL LBS RESISTIVE MOMENT K-FT HOLDOWN CAPACITY LBS

HOLD-DOWN SPECIFICATION

NO HOLDOWN REQUIRED

SHEARWALL XXX: - NOT USED

SHEARWALL PROPERTIES:

WALL HEIGHT, H FT. MAX WALL OPENING HT, H_c FT.
WALL LENGTH, L FT. QUALIFYING WALL LENGTH, L FT. SHEARWALL ASSEMBLY

CAPACITY EVALUATION:

TOTAL SHEAR LOAD ON WALL LBS ### ALLOWABLE SHEARWALL CAPACITY LBS

SHEARWALL ASSEMBLY SPECIFICATION

P1 - 1-SIDE 7/16" OSB
FASTENED W/ 8D NAILS AT 6"O.C. PANEL EDGES & 12"O.C. PANEL FIELD - EDGES BLOCKED
#DIV/0!

OVERTURNING EVALUATION:

RESISTIVE DL PLF OVERTURNING MOMENT K-FT HOLD DOWN DESIGN LOAD LBS
DL AT ENDS OF WALL LBS RESISTIVE MOMENT K-FT HOLDOWN CAPACITY LBS

HOLD-DOWN SPECIFICATION

NO HOLDOWN REQUIRED



SHEARWALL DESIGN SUMMARY

SHEARWALL XXX: - NOT USED

SHEARWALL PROPERTIES:

WALL HEIGHT, H FT. MAX WALL OPENING HT, H_c FT.
WALL LENGTH, L FT. QUALIFYING WALL LENGTH, L FT. SHEARWALL ASSEMBLY

CAPACITY EVALUATION:

TOTAL SHEAR LOAD ON WALL LBS ALLOWABLE SHEARWALL CAPACITY LBS
#DIV/0!

SHEARWALL ASSEMBLY SPECIFICATION

P1 - 1-SIDE 7/16" OSB
FASTENED W/ 8D NAILS AT 6"O.C. PANEL EDGES & 12"O.C. PANEL FIELD - EDGES BLOCKED
#DIV/0!

OVERTURNING EVALUATION:

RESISTIVE DL PLF OVERTURNING MOMENT K-FT UPLIFT CONNECTOR DESIGN LOAD LBS
DL AT ENDS OF WALL LBS RESISTIVE MOMENT K-FT HOLDOWN CAPACITY LBS

HOLD-DOWN SPECIFICATION

NO HOLDOWN REQUIRED

SHEARWALL 1: BASEMENT - SIDE INT. WALL @ THEATER (TYP. OF 2)

SHEARWALL PROPERTIES:

WALL HEIGHT, H FT. MAX WALL OPENING HT, H_c FT.
WALL LENGTH, L FT. QUALIFYING WALL LENGTH, L FT. SHEARWALL ASSEMBLY

CAPACITY EVALUATION:

TOTAL SHEAR LOAD ON WALL LBS ALLOWABLE SHEARWALL CAPACITY LBS
<

SHEARWALL ASSEMBLY SPECIFICATION

P1 - 1-SIDE 7/16" OSB
FASTENED W/ 8D NAILS AT 6"O.C. PANEL EDGES & 12"O.C. PANEL FIELD - EDGES BLOCKED
ADEQUATE

OVERTURNING EVALUATION:

RESISTIVE DL PLF OVERTURNING MOMENT K-FT HOLD DOWN DESIGN LOAD LBS
DL AT ENDS OF WALL LBS RESISTIVE MOMENT K-FT HOLDOWN CAPACITY LBS

HOLD-DOWN SPECIFICATION

SIMPSON STHD14RJ HOLDOWN



SHEARWALL DESIGN SUMMARY

SHEARWALL 2: BASEMENT - REAR EXT. WALL @ REC

SHEARWALL PROPERTIES:

WALL HEIGHT, H FT. MAX WALL OPENING HT, H_c FT.
WALL LENGTH, L FT. QUALIFYING WALL LENGTH, L FT. SHEARWALL ASSEMBLY

CAPACITY EVALUATION:

TOTAL SHEAR LOAD ON WALL LBS < ALLOWABLE SHEARWALL CAPACITY LBS

SHEARWALL ASSEMBLY SPECIFICATION

P3 - 1-SIDE 7/16" OSB
FASTENED W/ 8D NAILS AT 3"O.C. PANEL EDGES & 12"O.C. PANEL FIELD - EDGES BLOCKED
ADEQUATE

OVERTURNING EVALUATION:

RESISTIVE DL PLF OVERTURNING MOMENT K-FT UPLIFT CONNECTOR DESIGN LOAD LBS
DL AT ENDS OF WALL LBS RESISTIVE MOMENT K-FT HOLDOWN CAPACITY LBS

HOLD-DOWN SPECIFICATION

SIMPSON HDU8-SDS2.5 HOLDOWN

SHEARWALL XXX: - NOT USED

SHEARWALL PROPERTIES:

WALL HEIGHT, H FT. MAX WALL OPENING HT, H_c FT.
WALL LENGTH, L FT. QUALIFYING WALL LENGTH, L FT. SHEARWALL ASSEMBLY

CAPACITY EVALUATION:

TOTAL SHEAR LOAD ON WALL LBS ### ALLOWABLE SHEARWALL CAPACITY LBS

SHEARWALL ASSEMBLY SPECIFICATION

P1 - 1-SIDE 7/16" OSB
FASTENED W/ 8D NAILS AT 6"O.C. PANEL EDGES & 12"O.C. PANEL FIELD - EDGES BLOCKED
#DIV/0!

OVERTURNING EVALUATION:

RESISTIVE DL PLF OVERTURNING MOMENT K-FT HOLD DOWN DESIGN LOAD LBS
DL AT ENDS OF WALL LBS RESISTIVE MOMENT K-FT HOLDOWN CAPACITY LBS

HOLD-DOWN SPECIFICATION

NO HOLDOWN REQUIRED

SEISMIC CALCULATION - ASCE 7-16

SEISMIC DESIGN CATEGORY:

USER INPUTS:

SITE CLASS	D
SPECTRAL RESPONSE ACCELERATION 0.2 SEC, S_s	1.453
SPECTRAL RESPONSE ACCELERATION 1.0 SEC, S₁	0.502
OCCUPANCY CATEGORY	II

VARIABLES:

SITE COEFFICIENT, F _A	1.00
SITE COEFFICIENT, F _V	1.80

CALCULATED VALUES:

MAXIMUM SPECTRAL RESPONSE ACCELERATION, S_{MS}	1.453
MAXIMUM SPECTRAL RESPONSE ACCELERATION, S_{M1}	0.903
DESIGN SPECTRAL RESPONSE ACCELERATION, S_{DS}	0.969
DESIGN SPECTRAL RESPONSE ACCELERATION, S_{D1}	0.602
SEISMIC DESIGN CATEGORY (SHORT TERM)	D
SEISMIC DESIGN CATEGORY (1.0 SECOND TERM)	D

BUILDING PERIOD DETERMINATION:

USER INPUTS:

BUILDING PERIOD COEFFICIENT, C _T	0.020
LONG-PERIOD TRANS PERIOD, T _L (SEC)	8
HT. ABV BASE TO HIGHEST LEVEL, h _N	35

CALCULATED VALUES:

APPROXIMATE FUNDAMENTAL PERIOD, T _A	0.285
T ₀	0.124
T _B	0.621
SPECTRAL RESPONSE ACC., S _A (G)	0.969

SITE CLASS ASSUMPTION

D PER ASCE 7-16 SECTION 11.4.3
THE SITE CLASS MAY BE ASSUMED
TO BE D

EQUIVALENT LATERAL FORCE PROCEDURE

DEAD LOAD CALCULATION:

LEVEL	STORY HT. (FT.)	AREA (FT ²)	DEAD LOAD (PSF)	DL OF EXT WALL TRIB. TO LEVEL (KIPS)	TOTAL LEVEL DL
1	12.0	2567	15	6.5	45 K
2	12.5	3643	15	13.0	68 K
3	10.1	2638	17	6.0	51 K
4	0.0	0	0	0.0	0 K
5	0.0	0	0	0.0	0 K
6	0.0	0	0	0.0	0 K
7	0.0	0	0	0.0	0 K
8	0.0	0	0	0.0	0 K
9	0.0	0	0	0.0	0 K
10	0.0	0	0	0.0	0 K
11	0.0	0	0	0.0	0 K
12	0.0	0	0	0.0	0 K
13	0.0	0	0	0.0	0 K
14	0.0	0	0	0.0	0 K
15	0.0	0	0	0.0	0 K
16	0.0	0	0	0.0	0 K
17	0.0	0	0	0.0	0 K
18	0.0	0	0	0.0	0 K
19	0.0	0	0	0.0	0 K
20	0.0	0	0	0.0	0 K

TOTAL DEAD LOAD OF STRUCTURE = 163 KIPS

SEISMIC RESPONSE COEFFICIENT:

	TRANSVERSE	LONGITUDINAL
RESPONSE MODIFICATION FACTOR, R	6.5	6.5
OCCUPANCY IMPORTANCE FACTOR, I _e	1.00	1.00
SEISMIC RESPONSE COEFFICIENT, C _s	0.149	0.149

BASE SHEARS:

ULTIMATE LOADS

x 0.7 =

ALLOWABLE LOADS

TRANSVERSE	LONGITUDINAL	TRANSVERSE	LONGITUDINAL
24 K	24 K	17.1 K	17.1 K

STORY SHEAR CALCULATION:

DISTRIBUTION EXPONENT, **1.00**

ULTIMATE LOADS

x 0.7 =

ALLOWABLE LOADS

LEVEL	VERT. DIST. FACTOR, C _{vk}	TRANSVERSE		LONGITUDINAL		TRANSVERSE		LONGITUDINAL	
		STORY SHEAR, F _v	STORY SHEAR, F _v	STORY SHEAR, F _v	STORY SHEAR, F _v	STORY SHEAR, F _v	STORY SHEAR, F _v	STORY SHEAR, F _v	STORY SHEAR, F _v
1	0.136	3.3 K	3.3 K	2.3 K	17.1 K	2.3 K	17.1 K		
2	0.419	10.2 K	10.2 K	7.1 K	14.7 K	7.1 K	14.7 K		
3	0.445	10.8 K	10.8 K	7.6 K	7.6 K	7.6 K	7.6 K		
4	0.000	0.0 K	0.0 K	0.0 K	0.0 K	0.0 K	0.0 K		
5	0.00	0.0 K	0.0 K	0.0 K	0.0 K	0.0 K	0.0 K		
6	0.00	0.0 K	0.0 K	0.0 K	0.0 K	0.0 K	0.0 K		
7	0.00	0.0 K	0.0 K	0.0 K	0.0 K	0.0 K	0.0 K		
8	0.00	0.0 K	0.0 K	0.0 K	0.0 K	0.0 K	0.0 K		
9	0.00	0.0 K	0.0 K	0.0 K	0.0 K	0.0 K	0.0 K		
10	0.00	0.0 K	0.0 K	0.0 K	0.0 K	0.0 K	0.0 K		
11	0.00	0.0 K	0.0 K	0.0 K	0.0 K	0.0 K	0.0 K		
12	0.00	0.0 K	0.0 K	0.0 K	0.0 K	0.0 K	0.0 K		
13	0.00	0.0 K	0.0 K	0.0 K	0.0 K	0.0 K	0.0 K		
14	0.00	0.0 K	0.0 K	0.0 K	0.0 K	0.0 K	0.0 K		
15	0.00	0.0 K	0.0 K	0.0 K	0.0 K	0.0 K	0.0 K		
16	0.00	0.0 K	0.0 K	0.0 K	0.0 K	0.0 K	0.0 K		
17	0.00	0.0 K	0.0 K	0.0 K	0.0 K	0.0 K	0.0 K		
18	0.00	0.0 K	0.0 K	0.0 K	0.0 K	0.0 K	0.0 K		
19	0.00	0.0 K	0.0 K	0.0 K	0.0 K	0.0 K	0.0 K		
20	0.00	0.0 K	0.0 K	0.0 K	0.0 K	0.0 K	0.0 K		

MCCULLOUGH ARCHITECTS

BARCELO HOMES - LOT 1

MERCER ISLAND, WA

SHEAR WALL CALCULATIONS - SEISMIC DESIGN

REVIEWED BY: NJM

DECEMBER 7, 2020

PARAMETERS:

SINGLE FAMILY HOME

DESIGN WIND SPEED: 110 MPH

WIND EXPOSURE CATEGORY: C

SEISMIC DESIGN CATEGORY: D

CODE & DESIGN STANDARD: 2018 IBC CH. 1609, ASCE 7-16 CH. 26-30



MULHERN+KULP
RESIDENTIAL STRUCTURAL ENGINEERING

GENERAL NOTES:

- DIMENSION LINES ARE TO FACE OF STUD U.N.O.
- WINDOW SIZES & ROUGH OPENINGS TO BE VERIFIED BY CONTRACTOR.
- IF NOMINAL DOOR AND WINDOW HEIGHTS ARE SIMILAR, COORDINATE WITH DOOR AND WINDOW SPECS TO LOCATE FINAL ELEVATION OF THE HEAD HEIGHTS SO THAT ALL DOOR AND WINDOW TRIM ALIGN.
- WINDOW AND DOOR SIZES ARE DIMENSIONED IN FEET AND INCHES (E.G. 2828= 2'-8" W X 2'-8" H)
- EXTERIOR WALLS TO BE 2X6 STUDS PER STRUCTURAL, INTERIOR WALLS TO BE 2X4 STUDS PER STRUCTURAL.
- FIREBLOCK ALL PLUMBING PENETRATIONS AND STAIR RUNS PER IRC SEC. R302.11.
- ALL WOOD IN CONTACT WITH CONCRETE TO BE PRESSURE TREATED PER IRC SEC. R317.1.
- PROVIDE UNDER-STAIR PROTECTION (1/2" GWB) PER IRC SEC R302.7.
- PROVIDE (1) LAYER OF 1/2" GWB AT THE GARAGE SIDE OF ALL WALLS SEPARATING THE GARAGE FROM THE RESIDENCE, ALL WALLS SUPPORTING A FLOOR CEILING ASSEMBLY BETWEEN THE GARAGE AND RESIDENCE, AND BETWEEN THE GARAGE AND ITS ATTIC. PROVIDE (1) LAYER 5/8" TYPE X GWB TO GARAGE CEILING IF BELOW HABITABLE ROOMS.
- HOUSE/GARAGE DOOR SHALL BE 1-3/4" THICK WOOD SOLID CORE, OR 1-3/4" THICK SOLID OR HONEYCOMB CORE STEEL DOOR, OR 20-MINUTE RATED FIRE DOOR. PROVIDE SELF-CLOSING DEVICE.
- DUCTS IN THE GARAGE AND DUCTS PENETRATING THE WALLS AND CEILINGS SEPARATING THE DWELLING FROM THE GARAGE SHALL BE MIN. 26 GAUGE GALVANIZED STEEL.
- PER IRC SEC R311.7.5, MAX. RISER HEIGHT SHALL BE 7-3/4". MAX. TREAD SHALL BE 10". STAIR NOSINGS: 3/4" MIN., 1-1/4" MAX. RADIUS. TREAD: 9/16" MAX.
- PROVIDE HANDRAILS PER IRC SEC. R311.7.8. TOP OF HANDRAIL SHALL BE 34" OR MORE THAN 38" ABOVE THE TREAD NOSINGS. HANDRAILS SHALL BE CONTINUOUS THE FULL LENGTH OF THE FLIGHT PER R311.7.8.3. THE HANDRAIL GRIP-SIZE SHALL BE PROVIDED PER R311.7.8.3.
- PROVIDE GUARDS (MIN. 36" HEIGHT) IN LOCATIONS PER IRC SEC. R312.
- FACTORY BUILT FIREPLACES & CHIMNEYS SHALL BE LISTED & LABELED AND SHALL BE INSTALLED & TERMINATED IN ACCORDANCE TO THE CONDITIONS OF THE LISTINGS. FACTORY BUILT FIREPLACES SHALL MEET EMISSION STANDARDS PER CH. 51-51 WAC R1004.1.1.
- PROVIDE EXTERIOR AIR SUPPLY TO ANY FACTORY-BUILT FIREPLACE PER IRC SEC R1006.
- WATER HEATERS SHALL COMPLY WITH THE REQUIREMENTS OF THE IRC CH. 20 AND 28.
- UNINSTALL PER MANUFACTURERS SPECIFICATIONS, PROVIDING ALL SPECIFIED CLEARANCES & VENTILATION.
- WATER HEATERS SHALL BE ANCHORED OR STRAPPED IN THE UPPER ONE-THIRD AND IN THE LOWER ONE-THIRD OF THE APPLIANCE.
- ALL SHOWER AND TUB FIXTURES TO HAVE THERMOSTATIC CONTROL W/ 120° F. MAX. SETTING FOR THERMAL PROTECTION PER UPC 408.3 & 409.4.

PLAN KEY:

- INDICATES 110V SMOKE DET. PER I.R.C. 314.3 INTERCONNECTED W/ EMERGENCY BATTERY BACKUP. MAY BE COMBINED
- INDICATES CARBON MONOXIDE ALARM PER I.R.C. R315.1
- INDICATES EXHAUST VENTILATION FAN. SEE "LOCAL EXHAUST" ON COVER SHEET FOR ADDITIONAL INFORMATION.
- INDICATES SHEAR WALL PER STRUCTURAL. SEE "TYPICAL EXTERIOR WALL SHEATHING SPECIFICATIONS" ON SHEET S-0.0.
- INDICATES HOLD DOWN PER STRUCTURAL NOTES. S-0.0
- SAFETY GLASS REQUIRED PER IRC R308

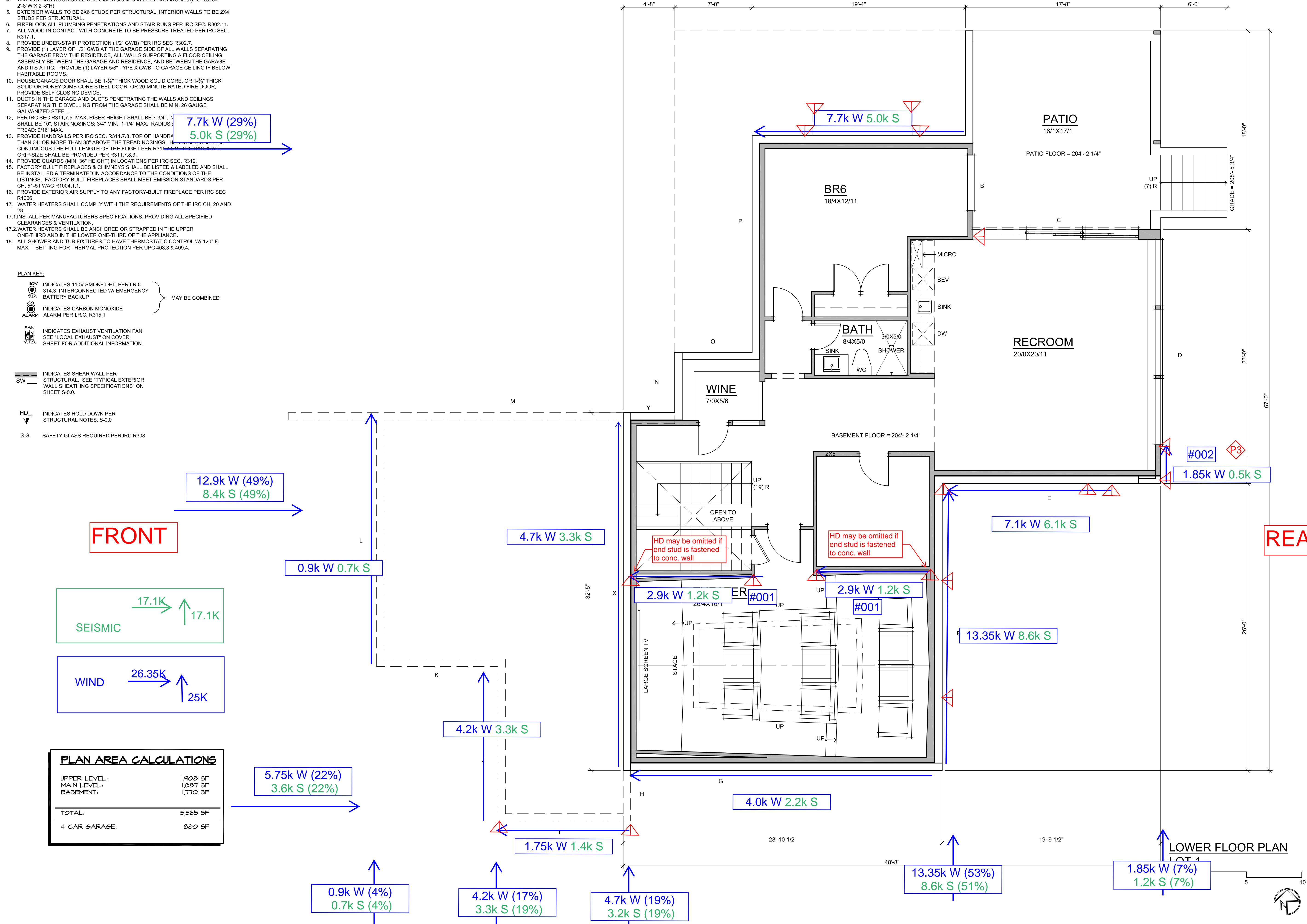

Revisions **Comment**

Date: 2020.11.23
 Job No: 19-034
 Project No: 00000
 Drawn: MCG
 Approved: APM
 Owner: Barcelo Homes

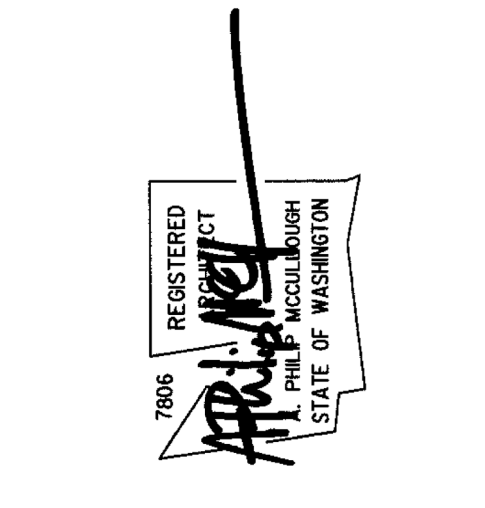

LOT 1
 7216 93rd AVE. SE
 MERCER ISLAND, WA 98040

GENERAL NOTES:

- DIMENSION LINES ARE TO FACE OF STUD U.N.O.
- WINDOW SIZES & ROUGH OPENINGS TO BE VERIFIED BY CONTRACTOR.
- IF NOMINAL DOOR AND WINDOW HEIGHTS ARE SIMILAR, COORDINATE WITH DOOR AND WINDOW SPEC'S TO LOCATE FINAL ELEVATION OF THE HEAD HEIGHTS SO THAT ALL DOOR AND WINDOW TRIM ALIGN.
- WINDOW AND DOOR SIZES ARE DIMENSIONED IN FEET AND INCHES (E.G. 2828= 2'-8" W X 2'-8" H).
- EXTERIOR WALLS TO BE 2X6 STUDS PER STRUCTURAL, INTERIOR WALLS TO BE 2X4 STUDS PER STRUCTURAL.
- FIREBLOCK ALL PLUMBING PENETRATIONS AND STAIR RUNS PER IRC SEC. R302.11.
- ALL WOOD IN CONTACT WITH CONCRETE TO BE PRESSURE TREATED PER IRC SEC. R317.1.
- PROVIDE UNDER-STAIR PROTECTION (1/2" GWB) PER IRC SEC R302.7.
- PROVIDE (1) LAYER OF 1/2" GWB AT THE GARAGE SIDE OF ALL WALLS SEPARATING THE GARAGE FROM THE RESIDENCE, ALL WALLS SUPPORTING A FLOOR CEILING ASSEMBLY BETWEEN THE GARAGE AND RESIDENCE, AND BETWEEN THE GARAGE AND ITS ATTIC. PROVIDE (1) LAYER 5/8" TYPE X GWB TO GARAGE CEILING IF BELOW HABITABLE ROOMS.
- HOUSE/GARAGE DOOR SHALL BE 1-3/4" THICK WOOD SOLID CORE, OR 1-3/4" THICK SOLID OR HONEYCOMB CORE STEEL DOOR, OR 20-MINUTE RATED FIRE DOOR. PROVIDE SELF-CLOSING DEVICE.
- DUCTS IN THE GARAGE AND DUCTS PENETRATING THE WALLS AND CEILINGS SEPARATING THE DWELLING FROM THE GARAGE SHALL BE MIN. 26 GAUGE GALVANIZED STEEL.
- PER IRC SEC R311.7.5, MAX. RISER HEIGHT SHALL BE 7-3/4". SHALL BE 10" STAIR NOSINGS: 3/4" MIN., 1-1/4" MAX. RADIUS TREAD: 9/16" MAX.
- PROVIDE HANDRAILS PER IRC SEC. R311.7.8, TOP OF HANDRAIL SHALL BE 34" OR MORE THAN 38" ABOVE THE TREAD NOSINGS. CONTINUOUS THE FULL LENGTH OF THE FLIGHT PER R311.7.8.3. GRIP-SIZE SHALL BE PROVIDED PER R311.7.8.3.
- PROVIDE GUARDS (MIN. 36" HEIGHT) IN LOCATIONS PER IRC SEC. R312.
- FACTORY BUILT FIREPLACES & CHIMNEYS SHALL BE LISTED & LABELED AND SHALL BE INSTALLED & TERMINATED IN ACCORDANCE TO THE CONDITIONS OF THE LISTINGS. FACTORY BUILT FIREPLACES SHALL MEET EMISSION STANDARDS PER CH. 51-51 WAC R1004.1.1.
- PROVIDE EXTERIOR AIR SUPPLY TO ANY FACTORY-BUILT FIREPLACE PER IRC SEC. R1006.
- WATER HEATERS SHALL COMPLY WITH THE REQUIREMENTS OF THE IRC CH. 20 AND 28.
- INSTALL PER MANUFACTURERS SPECIFICATIONS, PROVIDING ALL SPECIFIED CLEARANCES & VENTILATION.
- WATER HEATERS SHALL BE ANCHORED OR STRAPPED IN THE UPPER ONE-THIRD AND IN THE LOWER ONE-THIRD OF THE APPLIANCE.
- ALL SHOWER AND TUB FIXTURES TO HAVE THERMOSTATIC CONTROL W/ 120° F. MAX. SETTING FOR THERMAL PROTECTION PER UPC 408.3 & 409.4.

PLAN KEY:

- INDICATES 110V SMOKE DET. PER I.R.C. 314.3 INTERCONNECTED W/ EMERGENCY BATTERY BACKUP. MAY BE COMBINED
- INDICATES CARBON MONOXIDE ALARM PER I.R.C. R315.1
- INDICATES EXHAUST VENTILATION FAN. SEE "LOCAL EXHAUST" ON COVER SHEET FOR ADDITIONAL INFORMATION.
- INDICATES SHEAR WALL PER STRUCTURAL. SEE "TYPICAL EXTERIOR WALL SHEATHING SPECIFICATIONS" ON SHEET S-0.0.
- INDICATES HOLD DOWN PER STRUCTURAL NOTES. S-0.0
- SAFETY GLASS REQUIRED PER IRC R308

6.8k W (31%)
4.6k S (31%)

#105 & #106 have 514 plf (514 *336/630=274 plf) (427 plf (427*239/451=226 plf)) and 275 plf (224 plf) respectively. It is our professional opinion this is within an acceptable tolerance to be considered proportional

8.35k W (47%)
6.9k S (47%)

#101 & #102 have 139 plf (116 plf) and 146 plf (117 plf) respectively. It is our professional opinion this is within an acceptable tolerance to be considered proportional

3.9k W (22%)
3.2k S (22%)

PLAN AREA CALCULATIONS

UPPER LEVEL:	1,908 SF
MAIN LEVEL:	1,087 SF
BASEMENT:	1,770 SF
TOTAL:	5,565 SF
4 CAR GARAGE:	880 SF

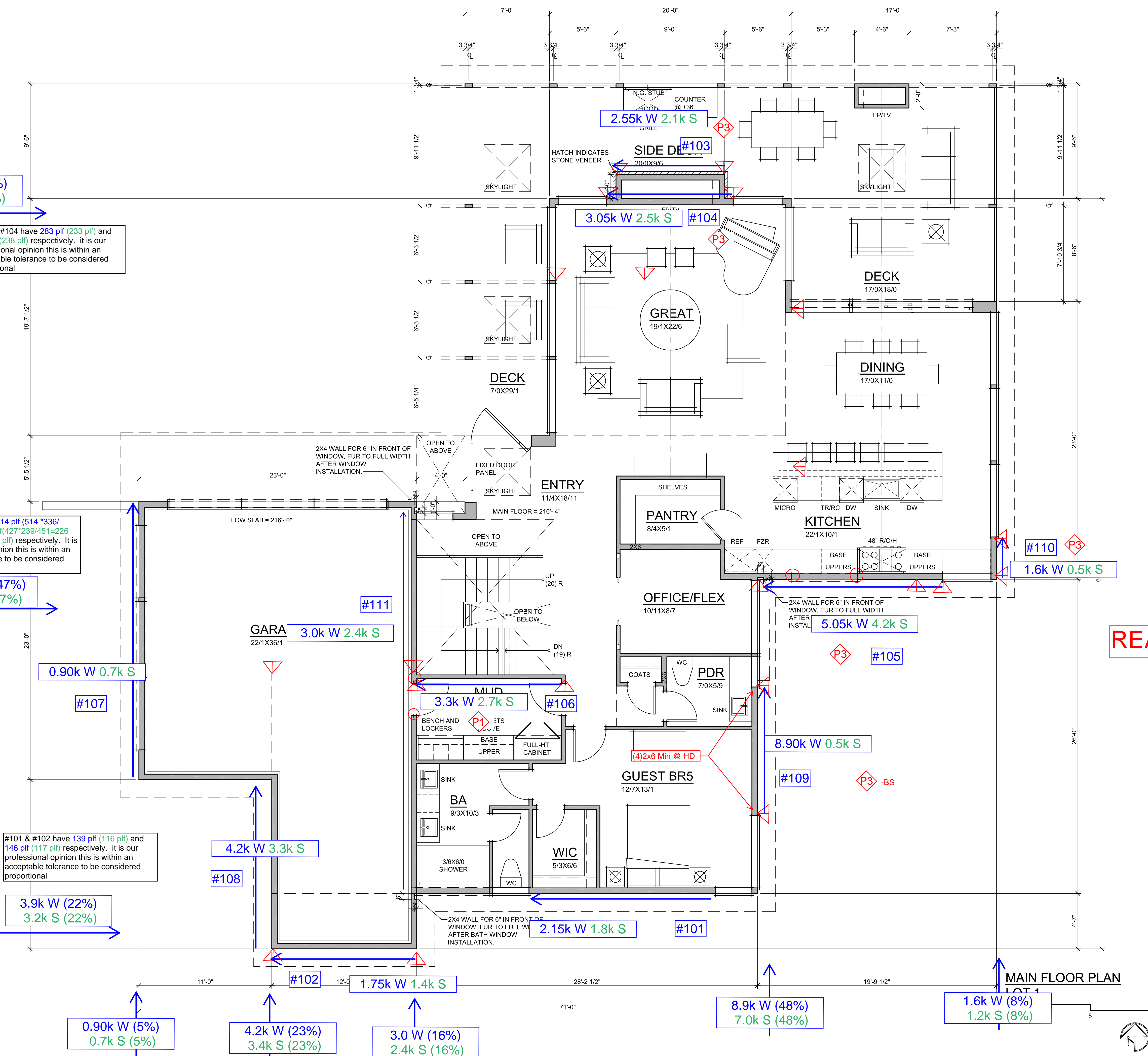

SEISMIC 14.7K ↑ 14.7K

WIND 17.85K → 18.6K ↑

FRONT

REAR

PLAN AREA CALCULATIONS

UPPER LEVEL:	1,908 SF
MAIN LEVEL:	1,087 SF
BASEMENT:	1,770 SF
TOTAL:	5,565 SF
4 CAR GARAGE:	880 SF

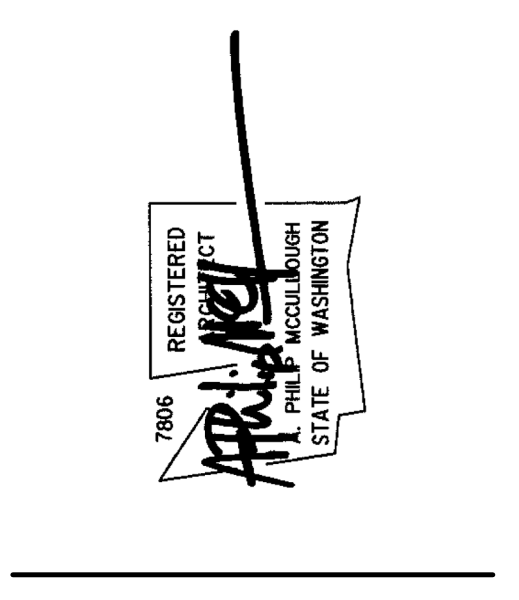

LOT 1
7216 93rd AVE. SE
MERCER ISLAND, WA 98040

GENERAL NOTES:

1. DIMENSION LINES ARE TO FACE OF STUD U.N.O.
2. WINDOW SIZES & ROUGH OPENINGS TO BE VERIFIED BY CONTRACTOR.
3. IF NOMINAL DOOR AND WINDOW HEIGHTS ARE SIMILAR, COORDINATE WITH DOOR AND WINDOW SPEC'S TO LOCATE FINAL ELEVATION OF THE HEAD HEIGHTS SO THAT ALL DOOR AND WINDOW TRIM ALIGN.
4. WINDOW AND DOOR SIZES ARE DIMENSIONED IN FEET AND INCHES (E.G. 2828= 2'-8" W X 2'-8" H).
5. EXTERIOR WALLS TO BE 2X6 STUDS PER STRUCTURAL, INTERIOR WALLS TO BE 2X4 STUDS PER STRUCTURAL.
6. FIREBLOCK ALL PLUMBING PENETRATIONS AND STAIR RUNS PER IRC SEC. R302.11.
7. ALL WOOD IN CONTACT WITH CONCRETE TO BE PRESSURE TREATED PER IRC SEC. R317.1.
8. PROVIDE UNDER-STAIR PROTECTION (1/2" GWB) PER IRC SEC R302.7.
9. PROVIDE (1) LAYER OF 1/2" GWB AT THE GARAGE SIDE OF ALL WALLS SEPARATING THE GARAGE FROM THE RESIDENCE, ALL WALLS SUPPORTING A FLOOR CEILING ASSEMBLY BETWEEN THE GARAGE AND RESIDENCE, AND BETWEEN THE GARAGE AND ITS ATTIC. PROVIDE (1) LAYER 5/8" TYPE X GWB TO GARAGE CEILING IF BELOW HABITABLE ROOMS.
10. HOUSE/GARAGE DOOR SHALL BE 1-3/4" THICK WOOD SOLID CORE, OR 1-3/4" THICK SOLID OR HONEYCOMB CORE STEEL DOOR, OR 20-MINUTE RATED FIRE DOOR, PROVIDE SELF-CLOSING DEVICE.
11. DUCTS IN THE GARAGE AND DUCTS PENETRATING THE WALLS AND CEILINGS SEPARATING THE DWELLING FROM THE GARAGE SHALL BE MIN. 26 GAUGE GALVANIZED STEEL.
12. PER IRC SEC R311.7.5, MAX. RISER HEIGHT SHALL BE 7-3/4". MIN. TREAD DEPTH SHALL BE 10". STAIR NOSINGS: 3/4" MIN., 1-1/4" MAX. RADIUS @ LEADING EDGE OF TREAD: 9/16" MAX.
13. PROVIDE HANDRAILS PER IRC SEC. R311.7.8, TOP OF HANDRAIL SHALL BE NOT LESS THAN 34" OR MORE THAN 38" ABOVE THE TREAD NOSINGS. HANDRAILS SHALL BE CONTINUOUS THE FULL LENGTH OF THE FLIGHT PER R311.7.8.2. THE HANDRAIL GRIP-SIZE SHALL BE PROVIDED PER R311.7.8.3.
14. PROVIDE GUARDS (MIN. 36" HEIGHT) IN LOCATIONS PER IRC SEC. R312.
15. FACTORY BUILT FIREPLACES & CHIMNEYS SHALL BE LISTED & LABELED AND SHALL BE INSTALLED & TERMINATED IN ACCORDANCE TO THE CONDITIONS OF THE LISTINGS. FACTORY BUILT FIREPLACES SHALL MEET EMISSION STANDARDS PER CH. 51-51 WAC R1004.1.1.
16. PROVIDE EXTERIOR AIR SUPPLY TO ANY FACTORY-BUILT FIREPLACE PER IRC SEC R1006.
17. WATER HEATERS SHALL COMPLY WITH THE REQUIREMENTS OF THE IRC CH. 20 AND 28.
- 17.1. UNINSTALL PER MANUFACTURERS SPECIFICATIONS, PROVIDING ALL SPECIFIED CLEARANCES & VENTILATION.
- 17.2. WATER HEATERS SHALL BE ANCHORED OR STRAPPED IN THE UPPER ONE-THIRD AND IN THE LOWER ONE-THIRD OF THE APPLIANCE.
18. ALL SHOWER AND TUB FIXTURES TO HAVE THERMOSTATIC CONTROL W/ 120° F. MAX. SETTING FOR THERMAL PROTECTION PER UPC 408.3 & 409.4.

PLAN KEY:

- IBV INDICATES 110V SMOKE DET. PER I.R.C. 314.3 INTERCONNECTED W/ EMERGENCY BATTERY BACKUP. MAY BE COMBINED
- CO INDICATES CARBON MONOXIDE ALARM PER I.R.C. R315.1
- FAN V.T.O. INDICATES EXHAUST VENTILATION FAN. SEE "LOCAL EXHAUST" ON COVER SHEET FOR ADDITIONAL INFORMATION.
- SW INDICATES SHEAR WALL PER STRUCTURAL (SEE "TYPICAL EXTERIOR WALL SHEATHING SPECIFICATIONS" ON SHEET S-0.0.)
- HD INDICATES HOLD DOWN PER STRUCTURAL NOTES. S-0.0
- S.G. SAFETY GLASS REQUIRED PER IRC R308

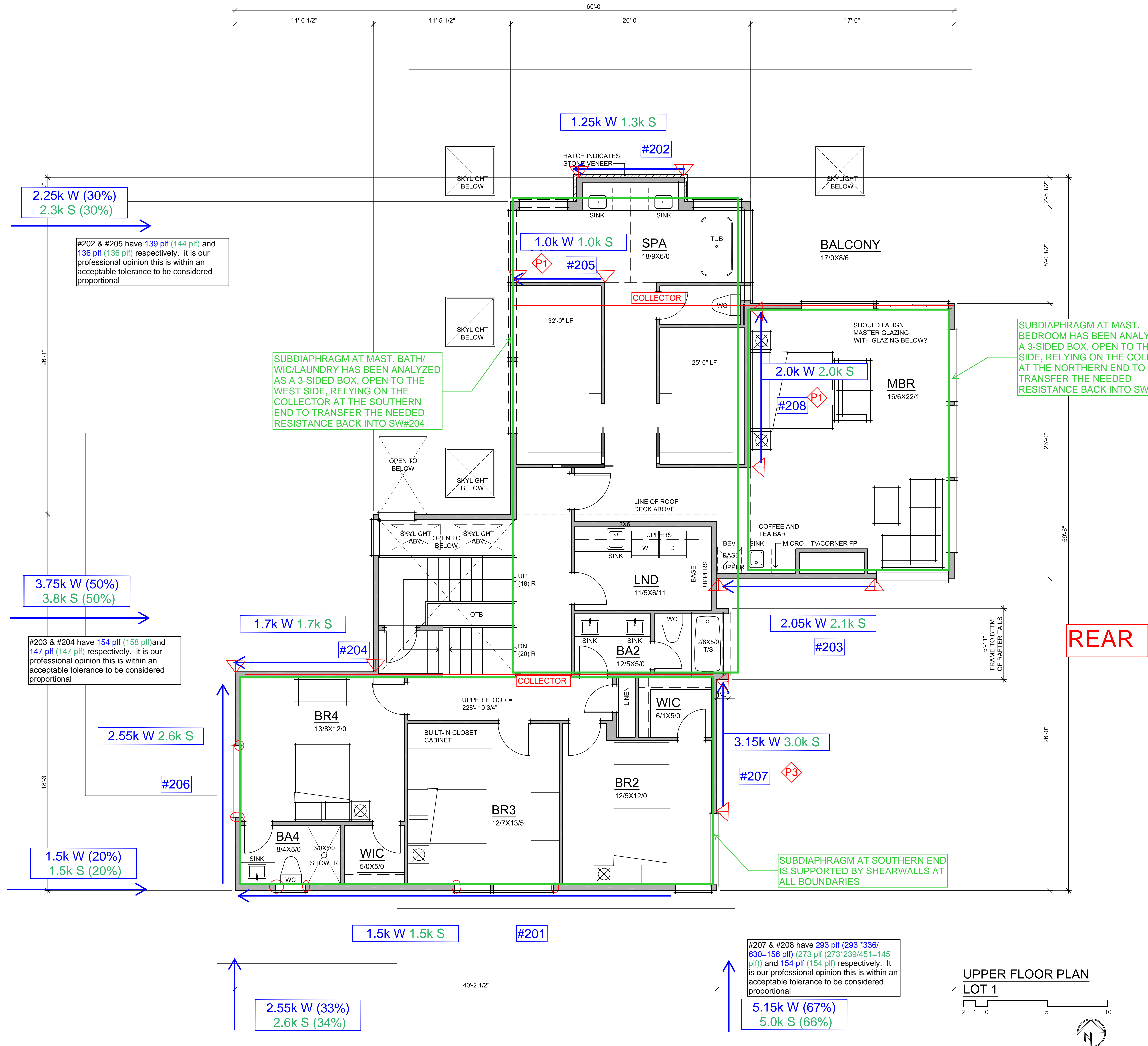

PLAN AREA CALCULATIONS

UPPER LEVEL:	1,908 SF
MAIN LEVEL:	1,087 SF
BASEMENT:	1,770 SF
TOTAL:	5,565 SF
4 CAR GARAGE:	880 SF

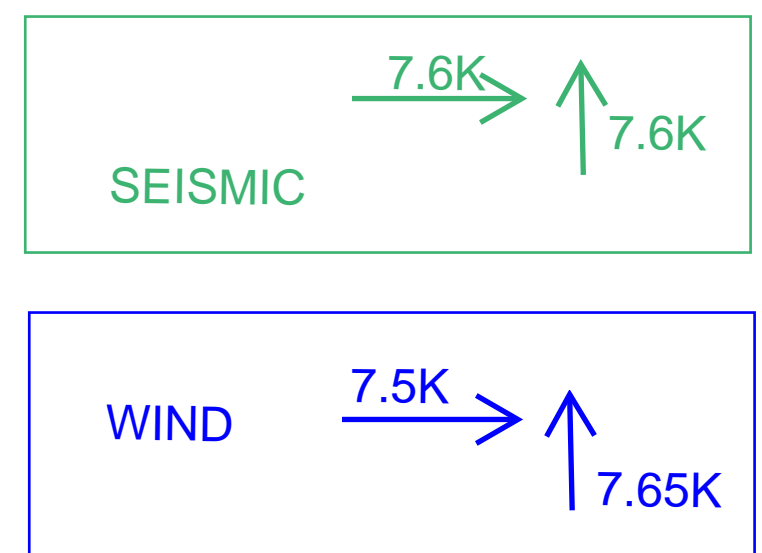

Revisions Comment

Date: 2020.11.23
 Job No: 19-034
 Project No: 00000
 Drawn: MCG
 Approved: APM
 Owner: Barcelo homes

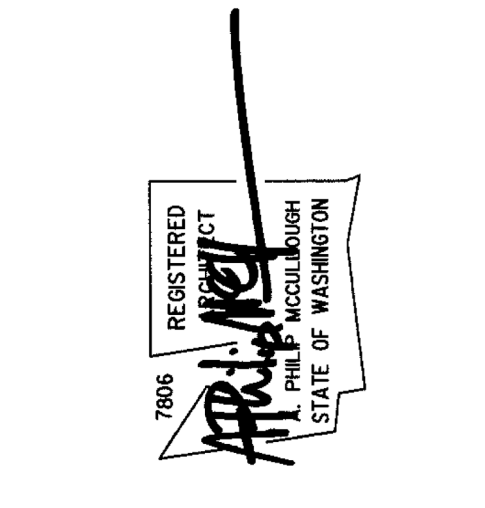

LOT 1
 7216 93rd AVE. SE
 MERCER ISLAND, WA 98040



SHEARWALL DESIGN SUMMARY

SHEARWALL 201: 2ND - SIDE EXT. WALL @ BED 2 TO BED 4

SHEARWALL PROPERTIES:

WALL HEIGHT, H FT. MAX WALL OPENING HT, H_c FT.
WALL LENGTH, L FT. QUALIFYING WALL LENGTH, L FT. SHEARWALL ASSEMBLY

CAPACITY EVALUATION:

TOTAL SHEAR LOAD ON WALL LBS < ALLOWABLE SHEARWALL CAPACITY LBS

SHEARWALL ASSEMBLY SPECIFICATION

P1 - 1-SIDE 7/16" OSB
FASTENED W/ 8D NAILS AT 6"O.C. PANEL EDGES & 12"O.C. PANEL FIELD - EDGES BLOCKED
ADEQUATE

OVERTURNING EVALUATION:

RESISTIVE DL PLF OVERTURNING MOMENT K-FT HOLD DOWN DESIGN LOAD LBS
DL AT ENDS OF WALL LBS RESISTIVE MOMENT K-FT HOLDDOWN CAPACITY LBS

HOLD-DOWN SPECIFICATION

NO HOLDDOWN REQUIRED

SHEARWALL 202: 2ND - SIDE EXT. WALL @ MASTER BATH

SHEARWALL PROPERTIES:

WALL HEIGHT, H FT. MAX WALL OPENING HT, H_c FT.
WALL LENGTH, L FT. QUALIFYING WALL LENGTH, L FT. SHEARWALL ASSEMBLY

CAPACITY EVALUATION:

TOTAL SHEAR LOAD ON WALL LBS < ALLOWABLE SHEARWALL CAPACITY LBS

SHEARWALL ASSEMBLY SPECIFICATION

P1 - 1-SIDE 7/16" OSB
FASTENED W/ 8D NAILS AT 6"O.C. PANEL EDGES & 12"O.C. PANEL FIELD - EDGES BLOCKED
ADEQUATE

OVERTURNING EVALUATION:

RESISTIVE DL PLF OVERTURNING MOMENT K-FT HOLD DOWN DESIGN LOAD LBS
DL AT ENDS OF WALL LBS RESISTIVE MOMENT K-FT HOLDDOWN CAPACITY LBS

HOLD-DOWN SPECIFICATION

SIMPSON CS 16 STRAP TIE (14" END LENGTH)



SHEARWALL DESIGN SUMMARY

SHEARWALL 203: 2ND - SIDE EXT. WALL @ MASTER BED

SHEARWALL PROPERTIES:

WALL HEIGHT, H FT. MAX WALL OPENING HT, H_c FT.
WALL LENGTH, L FT. QUALIFYING WALL LENGTH, L FT. SHEARWALL ASSEMBLY

CAPACITY EVALUATION:

TOTAL SHEAR LOAD ON WALL LBS < ALLOWABLE SHEARWALL CAPACITY LBS

SHEARWALL ASSEMBLY SPECIFICATION

P1 - 1-SIDE 7/16" OSB
FASTENED W/ 8D NAILS AT 6"O.C. PANEL EDGES & 12"O.C. PANEL FIELD - EDGES BLOCKED
ADEQUATE

OVERTURNING EVALUATION:

RESISTIVE DL PLF OVERTURNING MOMENT K-FT UPLIFT CONNECTOR DESIGN LOAD LBS
DL AT ENDS OF WALL LBS RESISTIVE MOMENT K-FT HOLDOWN CAPACITY LBS

HOLD-DOWN SPECIFICATION

SIMPSON CS 16 STRAP TIE (14" END LENGTH)

SHEARWALL 204: 2ND - SIDE EXT. WALL @ BED 4

SHEARWALL PROPERTIES:

WALL HEIGHT, H FT. MAX WALL OPENING HT, H_c FT.
WALL LENGTH, L FT. QUALIFYING WALL LENGTH, L FT. SHEARWALL ASSEMBLY

CAPACITY EVALUATION:

TOTAL SHEAR LOAD ON WALL LBS < ALLOWABLE SHEARWALL CAPACITY LBS

SHEARWALL ASSEMBLY SPECIFICATION

P1 - 1-SIDE 7/16" OSB
FASTENED W/ 8D NAILS AT 6"O.C. PANEL EDGES & 12"O.C. PANEL FIELD - EDGES BLOCKED
ADEQUATE

OVERTURNING EVALUATION:

RESISTIVE DL PLF OVERTURNING MOMENT K-FT HOLD DOWN DESIGN LOAD LBS
DL AT ENDS OF WALL LBS RESISTIVE MOMENT K-FT HOLDOWN CAPACITY LBS

HOLD-DOWN SPECIFICATION

SIMPSON CS 16 STRAP TIE (14" END LENGTH)



SHEARWALL DESIGN SUMMARY

SHEARWALL 205: 2ND - SIDE INT. WALL @ SPA

SHEARWALL PROPERTIES:

WALL HEIGHT, H FT. MAX WALL OPENING HT, H_c FT.
WALL LENGTH, L FT. QUALIFYING WALL LENGTH, L FT. SHEARWALL ASSEMBLY

CAPACITY EVALUATION:

TOTAL SHEAR LOAD ON WALL LBS < ALLOWABLE SHEARWALL CAPACITY LBS

SHEARWALL ASSEMBLY SPECIFICATION

P1 - 1-SIDE 7/16" OSB
FASTENED W/ 8D NAILS AT 6"D.C. PANEL EDGES & 12"D.C. PANEL FIELD - EDGES BLOCKED
ADEQUATE

OVERTURNING EVALUATION:

RESISTIVE DL PLF OVERTURNING MOMENT K-FT UPLIFT CONNECTOR DESIGN LOAD LBS
DL AT ENDS OF WALL LBS RESISTIVE MOMENT K-FT HOLDOWN CAPACITY LBS

HOLD-DOWN SPECIFICATION

SIMPSON CS 16 STRAP TIE (14" END LENGTH)

SHEARWALL 206: 2ND - FRONT EXT. WALL @ BED 4

SHEARWALL PROPERTIES:

WALL HEIGHT, H FT. MAX WALL OPENING HT, H_c FT.
WALL LENGTH, L FT. QUALIFYING WALL LENGTH, L FT. SHEARWALL ASSEMBLY

CAPACITY EVALUATION:

TOTAL SHEAR LOAD ON WALL LBS < ALLOWABLE SHEARWALL CAPACITY LBS

SHEARWALL ASSEMBLY SPECIFICATION

P1 - 1-SIDE 7/16" OSB
FASTENED W/ 8D NAILS AT 6"D.C. PANEL EDGES & 12"D.C. PANEL FIELD - EDGES BLOCKED
ADEQUATE

OVERTURNING EVALUATION:

RESISTIVE DL PLF OVERTURNING MOMENT K-FT HOLD DOWN DESIGN LOAD LBS
DL AT ENDS OF WALL LBS RESISTIVE MOMENT K-FT HOLDOWN CAPACITY LBS

HOLD-DOWN SPECIFICATION

NO HOLDOWN REQUIRED



SHEARWALL DESIGN SUMMARY

SHEARWALL 207: 2ND - REAR EXT. WALL @ BED 2

SHEARWALL PROPERTIES:

WALL HEIGHT, H	<input type="text" value="8.8"/>	FT.	MAX WALL OPENING HT, H _c	<input type="text" value="0.0"/>	FT.		
WALL LENGTH, L	<input type="text" value="10.8"/>	FT.	QUALIFYING WALL LENGTH, L	<input type="text" value="10.8"/>	FT.	SHEARWALL ASSEMBLY	<input type="text" value="P3"/>

CAPACITY EVALUATION:

TOTAL SHEAR LOAD ON WALL	<input type="text" value="3000"/>	LBS	<	ALLOWABLE SHEARWALL CAPACITY	<input type="text" value="4848"/>	LBS
--------------------------	-----------------------------------	-----	---	------------------------------	-----------------------------------	-----

SHEARWALL ASSEMBLY SPECIFICATION

P3 - 1-SIDE 7/16" OSB
FASTENED W/ 8D NAILS AT 3"D.C. PANEL EDGES & 12"D.C. PANEL FIELD - EDGES BLOCKED
ADEQUATE

OVERTURNING EVALUATION:

RESISTIVE DL	<input type="text" value="270"/>	PLF	OVERTURNING MOMENT	<input type="text" value="26.5"/>	K-FT	UPLIFT CONNECTOR DESIGN LOAD	<input type="text" value="1613"/>	LBS
DL AT ENDS OF WALL	<input type="text" value="400"/>	LBS	RESISTIVE MOMENT	<input type="text" value="9.2"/>	K-FT	HOLDOWN CAPACITY	<input type="text" value="1705"/>	LBS

HOLD-DOWN SPECIFICATION

SIMPSON CS 16 STRAP TIE (14" END LENGTH)

SHEARWALL 208: 2ND - REAR INT WALL @ MASTER BED

SHEARWALL PROPERTIES:

WALL HEIGHT, H	<input type="text" value="9.5"/>	FT.	MAX WALL OPENING HT, H _c	<input type="text" value="0.0"/>	FT.		
WALL LENGTH, L	<input type="text" value="13.0"/>	FT.	QUALIFYING WALL LENGTH, L	<input type="text" value="13.0"/>	FT.	SHEARWALL ASSEMBLY	<input type="text" value="P1"/>

CAPACITY EVALUATION:

TOTAL SHEAR LOAD ON WALL	<input type="text" value="2000"/>	LBS	<	ALLOWABLE SHEARWALL CAPACITY	<input type="text" value="3107"/>	LBS
--------------------------	-----------------------------------	-----	---	------------------------------	-----------------------------------	-----

SHEARWALL ASSEMBLY SPECIFICATION

P1 - 1-SIDE 7/16" OSB
FASTENED W/ 8D NAILS AT 6"D.C. PANEL EDGES & 12"D.C. PANEL FIELD - EDGES BLOCKED
ADEQUATE

OVERTURNING EVALUATION:

RESISTIVE DL	<input type="text" value="100"/>	PLF	OVERTURNING MOMENT	<input type="text" value="19.0"/>	K-FT	HOLD DOWN DESIGN LOAD	<input type="text" value="979"/>	LBS
DL AT ENDS OF WALL	<input type="text" value="400"/>	LBS	RESISTIVE MOMENT	<input type="text" value="6.3"/>	K-FT	HOLDOWN CAPACITY	<input type="text" value="1705"/>	LBS

HOLD-DOWN SPECIFICATION

SIMPSON CS 16 STRAP TIE (14" END LENGTH)



SHEARWALL DESIGN SUMMARY

SHEARWALL XXX: - NOT USED

SHEARWALL PROPERTIES:

WALL HEIGHT, H FT. MAX WALL OPENING HT, H_c FT.
WALL LENGTH, L FT. QUALIFYING WALL LENGTH, L FT. SHEARWALL ASSEMBLY

CAPACITY EVALUATION:

TOTAL SHEAR LOAD ON WALL LBS ALLOWABLE SHEARWALL CAPACITY LBS
#DIV/0!

SHEARWALL ASSEMBLY SPECIFICATION

P1 - 1-SIDE 7/16" OSB
FASTENED W/ 8D NAILS AT 6"O.C. PANEL EDGES & 12"O.C. PANEL FIELD - EDGES BLOCKED
#DIV/0!

OVERTURNING EVALUATION:

RESISTIVE DL PLF OVERTURNING MOMENT K-FT UPLIFT CONNECTOR DESIGN LOAD LBS
DL AT ENDS OF WALL LBS RESISTIVE MOMENT K-FT HOLDOWN CAPACITY LBS

HOLD-DOWN SPECIFICATION

NO HOLDOWN REQUIRED

SHEARWALL XXX: - NOT USED

SHEARWALL PROPERTIES:

WALL HEIGHT, H FT. MAX WALL OPENING HT, H_c FT.
WALL LENGTH, L FT. QUALIFYING WALL LENGTH, L FT. SHEARWALL ASSEMBLY

CAPACITY EVALUATION:

TOTAL SHEAR LOAD ON WALL LBS ALLOWABLE SHEARWALL CAPACITY LBS
#DIV/0!

SHEARWALL ASSEMBLY SPECIFICATION

P1 - 1-SIDE 7/16" OSB
FASTENED W/ 8D NAILS AT 6"O.C. PANEL EDGES & 12"O.C. PANEL FIELD - EDGES BLOCKED
#DIV/0!

OVERTURNING EVALUATION:

RESISTIVE DL PLF OVERTURNING MOMENT K-FT HOLD DOWN DESIGN LOAD LBS
DL AT ENDS OF WALL LBS RESISTIVE MOMENT K-FT HOLDOWN CAPACITY LBS

HOLD-DOWN SPECIFICATION

NO HOLDOWN REQUIRED



SHEARWALL DESIGN SUMMARY

SHEARWALL 101: 1ST - SIDE EXT. WALL @ GUEST

SHEARWALL PROPERTIES:

WALL HEIGHT, H FT. MAX WALL OPENING HT, H_c FT.
WALL LENGTH, L FT. QUALIFYING WALL LENGTH, L FT. SHEARWALL ASSEMBLY

CAPACITY EVALUATION:

TOTAL SHEAR LOAD ON WALL LBS < ALLOWABLE SHEARWALL CAPACITY LBS

SHEARWALL ASSEMBLY SPECIFICATION

P1 - 1-SIDE 7/16" OSB
FASTENED W/ 8D NAILS AT 6"O.C. PANEL EDGES & 12"O.C. PANEL FIELD - EDGES BLOCKED
ADEQUATE

OVERTURNING EVALUATION:

RESISTIVE DL PLF OVERTURNING MOMENT K-FT UPLIFT CONNECTOR DESIGN LOAD LBS
DL AT ENDS OF WALL LBS RESISTIVE MOMENT K-FT HOLDOWN CAPACITY LBS

HOLD-DOWN SPECIFICATION

NO HOLDOWN REQUIRED

SHEARWALL 102: 1ST - SIDE EXT. WALL @ GARAGE

SHEARWALL PROPERTIES:

WALL HEIGHT, H FT. MAX WALL OPENING HT, H_c FT.
WALL LENGTH, L FT. QUALIFYING WALL LENGTH, L FT. SHEARWALL ASSEMBLY

CAPACITY EVALUATION:

TOTAL SHEAR LOAD ON WALL LBS < ALLOWABLE SHEARWALL CAPACITY LBS

SHEARWALL ASSEMBLY SPECIFICATION

P1 - 1-SIDE 7/16" OSB
FASTENED W/ 8D NAILS AT 6"O.C. PANEL EDGES & 12"O.C. PANEL FIELD - EDGES BLOCKED
ADEQUATE

OVERTURNING EVALUATION:

RESISTIVE DL PLF OVERTURNING MOMENT K-FT HOLD DOWN DESIGN LOAD LBS
DL AT ENDS OF WALL LBS RESISTIVE MOMENT K-FT HOLDOWN CAPACITY LBS

HOLD-DOWN SPECIFICATION

SIMPSON STHD14RJ HOLDOWN



SHEARWALL DESIGN SUMMARY

SHEARWALL 103: 1ST - SIDE EXT. WALL @ FIREPLACE

SHEARWALL PROPERTIES:

WALL HEIGHT, H FT. MAX WALL OPENING HT, H_c FT.
WALL LENGTH, L FT. QUALIFYING WALL LENGTH, L FT. SHEARWALL ASSEMBLY

CAPACITY EVALUATION:

TOTAL SHEAR LOAD ON WALL LBS < ALLOWABLE SHEARWALL CAPACITY LBS

SHEARWALL ASSEMBLY SPECIFICATION

P3 - 1-SIDE 7/16" OSB
FASTENED W/ 8D NAILS AT 3"O.C. PANEL EDGES & 12"O.C. PANEL FIELD - EDGES BLOCKED
ADEQUATE

OVERTURNING EVALUATION:

RESISTIVE DL PLF OVERTURNING MOMENT K-FT UPLIFT CONNECTOR DESIGN LOAD LBS
DL AT ENDS OF WALL LBS RESISTIVE MOMENT K-FT HOLDOWN CAPACITY LBS

HOLD-DOWN SPECIFICATION

SIMPSON MSTC66 STRAP TIE (20" END LENGTH)

SHEARWALL 104: 1ST - SIDE EXT. WALL @ GREAT ROOM

SHEARWALL PROPERTIES:

WALL HEIGHT, H FT. MAX WALL OPENING HT, H_c FT.
WALL LENGTH, L FT. QUALIFYING WALL LENGTH, L FT. SHEARWALL ASSEMBLY

CAPACITY EVALUATION:

TOTAL SHEAR LOAD ON WALL LBS < ALLOWABLE SHEARWALL CAPACITY LBS

SHEARWALL ASSEMBLY SPECIFICATION

P3 - 1-SIDE 7/16" OSB
FASTENED W/ 8D NAILS AT 3"O.C. PANEL EDGES & 12"O.C. PANEL FIELD - EDGES BLOCKED
ADEQUATE

OVERTURNING EVALUATION:

RESISTIVE DL PLF OVERTURNING MOMENT K-FT HOLD DOWN DESIGN LOAD LBS
DL AT ENDS OF WALL LBS RESISTIVE MOMENT K-FT HOLDOWN CAPACITY LBS

HOLD-DOWN SPECIFICATION

SIMPSON STHD14RJ HOLDOWN



SHEARWALL DESIGN SUMMARY

SHEARWALL 105: 1ST - SIDE EXT. WALL @ KITCHEN

SHEARWALL PROPERTIES:

WALL HEIGHT, H FT. MAX WALL OPENING HT, H_c FT.
WALL LENGTH, L FT. QUALIFYING WALL LENGTH, L FT. SHEARWALL ASSEMBLY

CAPACITY EVALUATION:

TOTAL SHEAR LOAD ON WALL LBS < ALLOWABLE SHEARWALL CAPACITY LBS

SHEARWALL ASSEMBLY SPECIFICATION

P3 - 1-SIDE 7/16" OSB
FASTENED W/ 8D NAILS AT 3"D.C. PANEL EDGES & 12"D.C. PANEL FIELD - EDGES BLOCKED
ADEQUATE

OVERTURNING EVALUATION:

RESISTIVE DL PLF OVERTURNING MOMENT K-FT UPLIFT CONNECTOR DESIGN LOAD LBS
DL AT ENDS OF WALL LBS RESISTIVE MOMENT K-FT HOLDOWN CAPACITY LBS

HOLD-DOWN SPECIFICATION

SIMPSON STDH14RJ HOLDOWN

SHEARWALL 106: 1ST - SIDE INT. WALL @ MUD

SHEARWALL PROPERTIES:

WALL HEIGHT, H FT. MAX WALL OPENING HT, H_c FT.
WALL LENGTH, L FT. QUALIFYING WALL LENGTH, L FT. SHEARWALL ASSEMBLY

CAPACITY EVALUATION:

TOTAL SHEAR LOAD ON WALL LBS < ALLOWABLE SHEARWALL CAPACITY LBS

SHEARWALL ASSEMBLY SPECIFICATION

P1 - 1-SIDE 7/16" OSB
FASTENED W/ 8D NAILS AT 6"D.C. PANEL EDGES & 12"D.C. PANEL FIELD - EDGES BLOCKED
ADEQUATE

OVERTURNING EVALUATION:

RESISTIVE DL PLF OVERTURNING MOMENT K-FT HOLD DOWN DESIGN LOAD LBS
DL AT ENDS OF WALL LBS RESISTIVE MOMENT K-FT HOLDOWN CAPACITY LBS

HOLD-DOWN SPECIFICATION

SIMPSON MSTC66 STRAP TIE (20" END LENGTH)



SHEARWALL DESIGN SUMMARY

SHEARWALL 107: 1ST - FRONT EXT. WALL @ GARAGE (LEFT)

SHEARWALL PROPERTIES:

WALL HEIGHT, H FT. MAX WALL OPENING HT, H_c FT.
WALL LENGTH, L FT. QUALIFYING WALL LENGTH, L FT. SHEARWALL ASSEMBLY

CAPACITY EVALUATION:

TOTAL SHEAR LOAD ON WALL LBS < ALLOWABLE SHEARWALL CAPACITY LBS

SHEARWALL ASSEMBLY SPECIFICATION

P1 - 1-SIDE 7/16" OSB
FASTENED W/ 8D NAILS AT 6"O.C. PANEL EDGES & 12"O.C. PANEL FIELD - EDGES BLOCKED
ADEQUATE

OVERTURNING EVALUATION:

RESISTIVE DL PLF OVERTURNING MOMENT K-FT UPLIFT CONNECTOR DESIGN LOAD LBS
DL AT ENDS OF WALL LBS RESISTIVE MOMENT K-FT HOLDOWN CAPACITY LBS

HOLD-DOWN SPECIFICATION

NO HOLDOWN REQUIRED

SHEARWALL 108: 1ST - FRONT EXT. WALL @ GARAGE (RIGHT)

SHEARWALL PROPERTIES:

WALL HEIGHT, H FT. MAX WALL OPENING HT, H_c FT.
WALL LENGTH, L FT. QUALIFYING WALL LENGTH, L FT. SHEARWALL ASSEMBLY

CAPACITY EVALUATION:

TOTAL SHEAR LOAD ON WALL LBS > ALLOWABLE SHEARWALL CAPACITY LBS

SHEARWALL ASSEMBLY SPECIFICATION

P1 - 1-SIDE 7/16" OSB
FASTENED W/ 8D NAILS AT 6"O.C. PANEL EDGES & 12"O.C. PANEL FIELD - EDGES BLOCKED
NO GOOD - CAPACITY EXCEEDED

OVERTURNING EVALUATION:

RESISTIVE DL PLF OVERTURNING MOMENT K-FT HOLD DOWN DESIGN LOAD LBS
DL AT ENDS OF WALL LBS RESISTIVE MOMENT K-FT HOLDOWN CAPACITY LBS

HOLD-DOWN SPECIFICATION

SIMPSON STHD14RJ HOLDOWN



SHEARWALL DESIGN SUMMARY

SHEARWALL 109: 1ST - REAR EXT. WALL @ GUEST

SHEARWALL PROPERTIES:

WALL HEIGHT, H FT. MAX WALL OPENING HT, H_c FT.
WALL LENGTH, L FT. QUALIFYING WALL LENGTH, L FT. SHEARWALL ASSEMBLY

CAPACITY EVALUATION:

TOTAL SHEAR LOAD ON WALL LBS < ALLOWABLE SHEARWALL CAPACITY LBS

SHEARWALL ASSEMBLY SPECIFICATION

P3-BS - 2-SIDES 7/16" OSB
FASTENED W/ 8D NAILS AT 3"O.C. PANEL EDGES & 12"O.C. PANEL FIELD - EDGES BLOCKED
ADEQUATE

OVERTURNING EVALUATION:

RESISTIVE DL PLF OVERTURNING MOMENT K-FT UPLIFT CONNECTOR DESIGN LOAD LBS
DL AT ENDS OF WALL LBS RESISTIVE MOMENT K-FT HOLDOWN CAPACITY LBS

HOLD-DOWN SPECIFICATION

SIMPSON HDU14-SDS2.5 HOLDOWN

SHEARWALL 110: 1ST - REAR EXT. WALL @ KITCHEN

SHEARWALL PROPERTIES:

WALL HEIGHT, H FT. MAX WALL OPENING HT, H_c FT.
WALL LENGTH, L FT. QUALIFYING WALL LENGTH, L FT. SHEARWALL ASSEMBLY

CAPACITY EVALUATION:

TOTAL SHEAR LOAD ON WALL LBS < ALLOWABLE SHEARWALL CAPACITY LBS

SHEARWALL ASSEMBLY SPECIFICATION

P3 - 1-SIDE 7/16" OSB
FASTENED W/ 8D NAILS AT 3"O.C. PANEL EDGES & 12"O.C. PANEL FIELD - EDGES BLOCKED
ADEQUATE

OVERTURNING EVALUATION:

RESISTIVE DL PLF OVERTURNING MOMENT K-FT HOLD DOWN DESIGN LOAD LBS
DL AT ENDS OF WALL LBS RESISTIVE MOMENT K-FT HOLDOWN CAPACITY LBS

HOLD-DOWN SPECIFICATION

SIMPSON MSTC78 STRAP TIE



SHEARWALL DESIGN SUMMARY

SHEARWALL 111: 1ST - FRONT INT. WALL @ GARAGE

SHEARWALL PROPERTIES:

WALL HEIGHT, H FT. MAX WALL OPENING HT, H_c FT.
WALL LENGTH, L FT. QUALIFYING WALL LENGTH, L FT. SHEARWALL ASSEMBLY

CAPACITY EVALUATION:

TOTAL SHEAR LOAD ON WALL LBS < ALLOWABLE SHEARWALL CAPACITY LBS

SHEARWALL ASSEMBLY SPECIFICATION

P1 - 1-SIDE 7/16" OSB
FASTENED W/ 8D NAILS AT 6"O.C. PANEL EDGES & 12"O.C. PANEL FIELD - EDGES BLOCKED
ADEQUATE

OVERTURNING EVALUATION:

RESISTIVE DL PLF OVERTURNING MOMENT K-FT UPLIFT CONNECTOR DESIGN LOAD LBS
DL AT ENDS OF WALL LBS RESISTIVE MOMENT K-FT HOLDOWN CAPACITY LBS

HOLD-DOWN SPECIFICATION

NO HOLDOWN REQUIRED

SHEARWALL XXX: - NOT USED

SHEARWALL PROPERTIES:

WALL HEIGHT, H FT. MAX WALL OPENING HT, H_c FT.
WALL LENGTH, L FT. QUALIFYING WALL LENGTH, L FT. SHEARWALL ASSEMBLY

CAPACITY EVALUATION:

TOTAL SHEAR LOAD ON WALL LBS **###** ALLOWABLE SHEARWALL CAPACITY LBS

SHEARWALL ASSEMBLY SPECIFICATION

P1 - 1-SIDE 7/16" OSB
FASTENED W/ 8D NAILS AT 6"O.C. PANEL EDGES & 12"O.C. PANEL FIELD - EDGES BLOCKED
#DIV/0!

OVERTURNING EVALUATION:

RESISTIVE DL PLF OVERTURNING MOMENT K-FT HOLD DOWN DESIGN LOAD LBS
DL AT ENDS OF WALL LBS RESISTIVE MOMENT K-FT HOLDOWN CAPACITY LBS

HOLD-DOWN SPECIFICATION

NO HOLDOWN REQUIRED



SHEARWALL DESIGN SUMMARY

SHEARWALL XXX: - NOT USED

SHEARWALL PROPERTIES:

WALL HEIGHT, H FT. MAX WALL OPENING HT, H_c FT.
WALL LENGTH, L FT. QUALIFYING WALL LENGTH, L FT. SHEARWALL ASSEMBLY

CAPACITY EVALUATION:

TOTAL SHEAR LOAD ON WALL LBS ALLOWABLE SHEARWALL CAPACITY LBS
 LBS **###** LBS

SHEARWALL ASSEMBLY SPECIFICATION

P1 - 1-SIDE 7/16" OSB
FASTENED W/ 8D NAILS AT 6"O.C. PANEL EDGES & 12"O.C. PANEL FIELD - EDGES BLOCKED
#DIV/0!

OVERTURNING EVALUATION:

RESISTIVE DL PLF OVERTURNING MOMENT K-FT UPLIFT CONNECTOR DESIGN LOAD LBS
DL AT ENDS OF WALL LBS RESISTIVE MOMENT K-FT HOLDOWN CAPACITY LBS

HOLD-DOWN SPECIFICATION

NO HOLDOWN REQUIRED

SHEARWALL 1: BASEMENT - SIDE INT. WALL @ THEATER (TYP. OF 2)

SHEARWALL PROPERTIES:

WALL HEIGHT, H FT. MAX WALL OPENING HT, H_c FT.
WALL LENGTH, L FT. QUALIFYING WALL LENGTH, L FT. SHEARWALL ASSEMBLY

CAPACITY EVALUATION:

TOTAL SHEAR LOAD ON WALL LBS ALLOWABLE SHEARWALL CAPACITY LBS
 LBS < LBS

SHEARWALL ASSEMBLY SPECIFICATION

P1 - 1-SIDE 7/16" OSB
FASTENED W/ 8D NAILS AT 6"O.C. PANEL EDGES & 12"O.C. PANEL FIELD - EDGES BLOCKED
ADEQUATE

OVERTURNING EVALUATION:

RESISTIVE DL PLF OVERTURNING MOMENT K-FT HOLD DOWN DESIGN LOAD LBS
DL AT ENDS OF WALL LBS RESISTIVE MOMENT K-FT HOLDOWN CAPACITY LBS

HOLD-DOWN SPECIFICATION

SIMPSON STHD14RJ HOLDOWN



SHEARWALL DESIGN SUMMARY

SHEARWALL 2: BASEMENT - REAR EXT. WALL @ REC

SHEARWALL PROPERTIES:

WALL HEIGHT, H FT. MAX WALL OPENING HT, H_c FT.
WALL LENGTH, L FT. QUALIFYING WALL LENGTH, L FT. SHEARWALL ASSEMBLY

CAPACITY EVALUATION:

TOTAL SHEAR LOAD ON WALL LBS < ALLOWABLE SHEARWALL CAPACITY LBS

SHEARWALL ASSEMBLY SPECIFICATION

P3 - 1-SIDE 7/16" OSB
FASTENED W/ 8D NAILS AT 3"O.C. PANEL EDGES & 12"O.C. PANEL FIELD - EDGES BLOCKED
ADEQUATE

OVERTURNING EVALUATION:

RESISTIVE DL PLF OVERTURNING MOMENT K-FT UPLIFT CONNECTOR DESIGN LOAD LBS
DL AT ENDS OF WALL LBS RESISTIVE MOMENT K-FT HOLDOWN CAPACITY LBS

HOLD-DOWN SPECIFICATION

SIMPSON HDU8-SDS2.5 HOLDOWN

SHEARWALL XXX: - NOT USED

SHEARWALL PROPERTIES:

WALL HEIGHT, H FT. MAX WALL OPENING HT, H_c FT.
WALL LENGTH, L FT. QUALIFYING WALL LENGTH, L FT. SHEARWALL ASSEMBLY

CAPACITY EVALUATION:

TOTAL SHEAR LOAD ON WALL LBS ### ALLOWABLE SHEARWALL CAPACITY LBS

SHEARWALL ASSEMBLY SPECIFICATION

P1 - 1-SIDE 7/16" OSB
FASTENED W/ 8D NAILS AT 6"O.C. PANEL EDGES & 12"O.C. PANEL FIELD - EDGES BLOCKED
#DIV/0!

OVERTURNING EVALUATION:

RESISTIVE DL PLF OVERTURNING MOMENT K-FT HOLD DOWN DESIGN LOAD LBS
DL AT ENDS OF WALL LBS RESISTIVE MOMENT K-FT HOLDOWN CAPACITY LBS

HOLD-DOWN SPECIFICATION

NO HOLDOWN REQUIRED

DETAIL 13 CALCULATION:

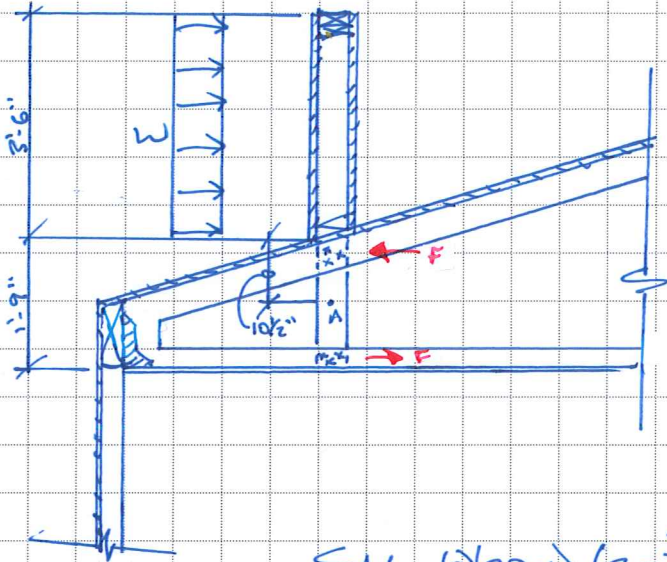

- BASED ON LOCATION ON PLAN, THERE WILL BE NO GUARDRAIL LOADS, AS THE WALL IS NOT ADJACENT TO LIVING SPACE.

- DESIGN STRESS FOR PARAPET WIND LOAD

$$W = 27.4 \text{ PSF}$$

F = REQ'D SHEAR CAPACITY OF SCREWS

$$\sum M_A = (2)(27.4)(3.5') (3.5' + .875') = F(1.75')$$

STUDS @ 24" O.C. PSF FT.

$$480\# = F$$

$$\frac{480\#}{3 \text{ (3 SCREWS)}} = 160\# / \text{SCREW}$$

- CAPACITY OF SIMPSON SDS SCREW = $245\# \times 1.6 = 392\#$

- PROVIDED SHEAR RESISTANCE OF SCREWS ($392\# \times 3 = 1176\#$) EXCEEDS THE REQ'D SHEAR CAPACITY TO RESIST THE WIND PRESSURES ON THE PARAPET WALL.

∴ DETAILED CONNECTIONS ADEQUATE



DETAIL 14

- EYEBROW ROOF DETAIL
- 1'-6" ROOF OVERHANG

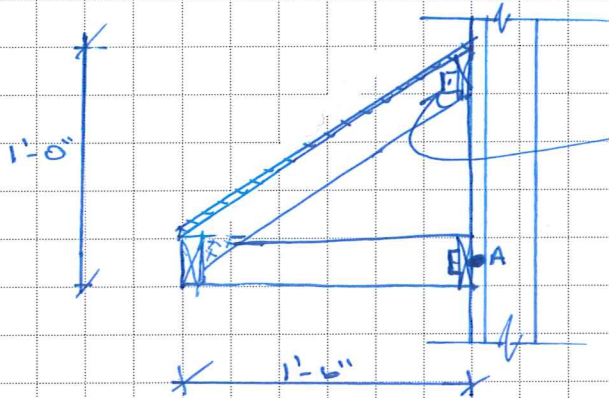

CHECK H3 CAPACITY.

LOADS:

10 PSF DL

25 PSF ZS

$w_{tot} = 35 \text{ PSF}$

T = REQ'D TENSION OF H3 CLIP

$$\Sigma M_A = (2)(35 \text{ PSF})(1.5')(1.5'/2) = T(1.0)$$
$$T = 78.75 \text{ lbs.}$$

- PUBLISHED VALUE FOR H3 CLIP IN FZ DIRECTION = $\frac{145 \text{ lbs.}}{1.6} \times 1.15$

TABLED VALUE IS FOR $C_o = 1.6$ \rightarrow $\rightarrow 104 \text{ lbs.}$

$$104 \text{ lbs.} > 78.75 \text{ lbs.}$$

\therefore H3 CLIP OK FOR TENSION LOAD.

PROJECT NAME: BARCELO LOT 1
DATE: 11/1/21
PROJECT NUMBER: 244-28519
DRAWN BY: NDA
SHEET: 1 OF 1

MULHERN+KULP
RESIDENTIAL STRUCTURAL ENGINEERING



300 Brookside Avenue, Building 4, Ambler, PA 19002 Telephone: 215-646-8001 mulhernkulp.com

DECK RAILING CALC

- @ SIDE OF MAST BALCONY

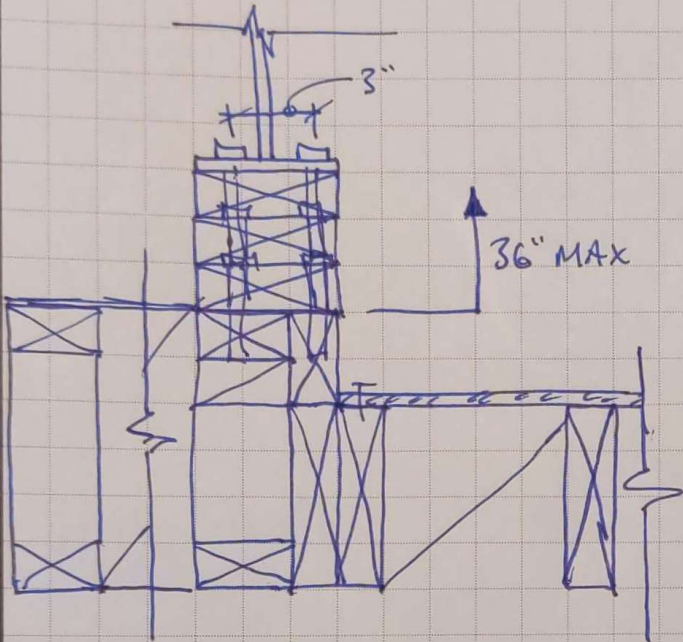

- DESIGN FOR 200# POINT LOAD @ TOP, PER IRC
- 36" RAILING HT. (MAX)

- $M_{APPLIED} = 200\# \times 36"$
 $= 7200\# \text{ in.}$

- FORCE COUPLE RESISTED BY SCREWS IN WITHDRAWAL
- PROVIDE SCREWS INTO EA. SUBSEQUENT 2x BELOW
- PROVIDE BULK EA. SIDE TO PREVENT ROTATION.

- SEE 43/SD-5 FOR MORE INFO -

$$\frac{7200\# \text{ in}}{3"} = 2400\# / 2 = 1200\#$$

↳ DESIGN EA. SCREW FOR 1200# UPLIFT CAPACITY.

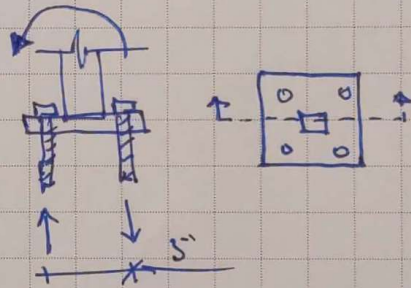

- PROVIDE 1/4" x 6" LONG LAG SCREWS (W=260#/in, SP)

$$260\#/\text{in} \times 1.6 \times 3\ 1/32" = 1391\# > 1200\#$$

α FACTOR ↗ (T-E, THREAD PENETRATION PER NDS TABLE L2)

∴ (4) 1/4" x 6" LAG SCREWS ARE ADEQUATE @ EA. GUARDRAIL BASE.



Concrete Beam

Lic. #: KW-06004787

File: Footing Calc.ec6
 Software copyright ENERCALC, INC. 1983-2020, Build:12.20.8.24
 MULHERN & KULP STRUCTURAL ENGINEERING INC

DESCRIPTION: 8"x16" continuous footing spanning 6' at footing step

CODE REFERENCES

Calculations per ACI 318-11, IBC 2012, CBC 2013, ASCE 7-10
 Load Combination Set : ASCE 7-16

Material Properties

f'_c	=	3.0 ksi	ϕ Phi Values	Flexure :	0.90
$f_r = f'_c^{1/2} * 7.50$	=	410.792 psi		Shear :	0.750
ψ Density	=	145.0 pcf	β_1	=	0.850
λ LtWt Factor	=	1.0			
Elastic Modulus	=	3,122.0 ksi	Fy - Stirrups	=	40.0 ksi
f _y - Main Rebar	=	60.0 ksi	E - Stirrups	=	29,000.0 ksi
E - Main Rebar	=	29,000.0 ksi	Stirrup Bar Size #	=	3
			Number of Resisting Legs Per Stirrup	=	2

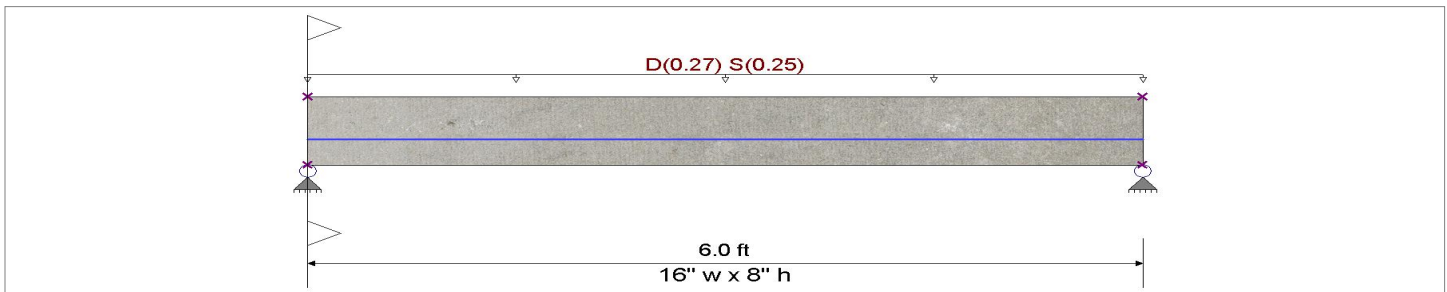
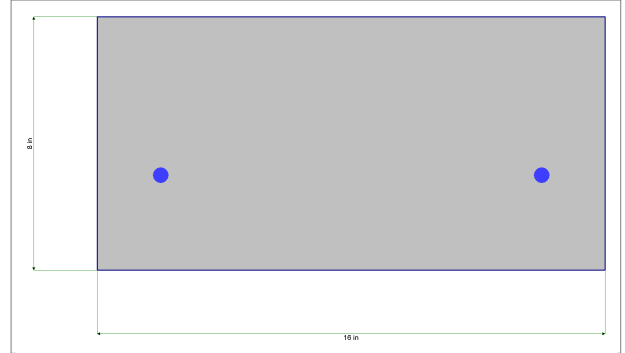

Cross Section & Reinforcing Details

Rectangular Section, Width = 16.0 in, Height = 8.0 in

Span #1 Reinforcing....

2-#4 at 3.0 in from Bottom, from 0.0 to 6.0 ft in this span

Beam self weight calculated and added to loads

Load for Span Number 1

Uniform Load : D = 0.270, S = 0.250 k/ft, Tributary Width = 1.0 ft

DESIGN SUMMARY

Design OK

Maximum Bending Stress Ratio =	0.467 : 1	Maximum Deflection	
Section used for this span	Typical Section	Max Downward Transient Deflection	0.003 in Ratio = 21056 >=360.
Mu : Applied	3.954 k-ft	Max Upward Transient Deflection	0.000 in Ratio = 0 <360.0
Mn * Phi : Allowable	8.471 k-ft	Max Downward Total Deflection	0.009 in Ratio = 8112 >=180.
Location of maximum on span	3.005 ft	Max Upward Total Deflection	0.000 in Ratio = 0 <180.0
Span # where maximum occurs	Span # 1		

Vertical Reactions

Support notation : Far left is #1

Load Combination	Support 1	Support 2
Overall MAXimum	1.947	1.947
Overall MINimum	0.718	0.718
+D+H	1.197	1.197
+D+L+H	1.197	1.197
+D+Lr+H	1.197	1.197
+D+S+H	1.947	1.947
+D+0.750Lr+0.750L+H	1.197	1.197
+D+0.750L+0.750S+H	1.759	1.759
+D+0.60W+H	1.197	1.197
+D+0.750Lr+0.750L+0.450W+H	1.197	1.197
+D+0.750L+0.750S+0.450W+H	1.759	1.759
+0.60D+0.60W+0.60H	0.718	0.718
+D+0.70E+0.60H	1.197	1.197

Concrete Beam

Lic. # : KW-06004787

DESCRIPTION: 8"x16" continuous footing spanning 6' at footing step

Vertical Reactions

Support notation : Far left is #1

Load Combination	Support 1	Support 2
+D+0.750L+0.750S+0.5250E+H	1.759	1.759
+0.60D+0.70E+H	0.718	0.718
D Only	1.197	1.197
S Only	0.750	0.750
H Only		

Detailed Shear Information

Load Combination	Span Number	Distance (ft)	'd' (in)	Vu (k)		Mu (k-ft)	d*Vu/Mu	Phi*Vc (k)	Comment	Phi*Vs (k)	Phi*Vn (k)	Spacing (in)	
				Actual	Design							Req'd	Suggest
+1.20D+1.60S+0.50W+1.60H	1	0.00	5.00	2.64	2.64	0.00	1.00	6.99	Vu < PhiVc/2	lot Reqd 11.4	7.0	0.0	0.0
+1.20D+1.60S+0.50W+1.60H	1	0.07	5.00	2.58	2.58	0.17	1.00	6.99	Vu < PhiVc/2	lot Reqd 11.4	7.0	0.0	0.0
+1.20D+1.60S+0.50W+1.60H	1	0.13	5.00	2.52	2.52	0.34	1.00	6.99	Vu < PhiVc/2	lot Reqd 11.4	7.0	0.0	0.0
+1.20D+1.60S+0.50W+1.60H	1	0.20	5.00	2.46	2.46	0.50	1.00	6.99	Vu < PhiVc/2	lot Reqd 11.4	7.0	0.0	0.0
+1.20D+1.60S+0.50W+1.60H	1	0.26	5.00	2.41	2.41	0.66	1.00	6.99	Vu < PhiVc/2	lot Reqd 11.4	7.0	0.0	0.0
+1.20D+1.60S+0.50W+1.60H	1	0.33	5.00	2.35	2.35	0.82	1.00	6.99	Vu < PhiVc/2	lot Reqd 11.4	7.0	0.0	0.0
+1.20D+1.60S+0.50W+1.60H	1	0.39	5.00	2.29	2.29	0.97	0.98	6.98	Vu < PhiVc/2	lot Reqd 11.4	7.0	0.0	0.0
+1.20D+1.60S+0.50W+1.60H	1	0.46	5.00	2.23	2.23	1.12	0.83	6.87	Vu < PhiVc/2	lot Reqd 11.4	6.9	0.0	0.0
+1.20D+1.60S+0.50W+1.60H	1	0.52	5.00	2.18	2.18	1.26	0.72	6.78	Vu < PhiVc/2	lot Reqd 11.4	6.8	0.0	0.0
+1.20D+1.60S+0.50W+1.60H	1	0.59	5.00	2.12	2.12	1.40	0.63	6.72	Vu < PhiVc/2	lot Reqd 11.4	6.7	0.0	0.0
+1.20D+1.60S+0.50W+1.60H	1	0.66	5.00	2.06	2.06	1.54	0.56	6.66	Vu < PhiVc/2	lot Reqd 11.4	6.7	0.0	0.0
+1.20D+1.60S+0.50W+1.60H	1	0.72	5.00	2.00	2.00	1.67	0.50	6.62	Vu < PhiVc/2	lot Reqd 11.4	6.6	0.0	0.0
+1.20D+1.60S+0.50W+1.60H	1	0.79	5.00	1.94	1.94	1.80	0.45	6.58	Vu < PhiVc/2	lot Reqd 11.4	6.6	0.0	0.0
+1.20D+1.60S+0.50W+1.60H	1	0.85	5.00	1.89	1.89	1.93	0.41	6.55	Vu < PhiVc/2	lot Reqd 11.4	6.5	0.0	0.0
+1.20D+1.60S+0.50W+1.60H	1	0.92	5.00	1.83	1.83	2.05	0.37	6.52	Vu < PhiVc/2	lot Reqd 11.4	6.5	0.0	0.0
+1.20D+1.60S+0.50W+1.60H	1	0.98	5.00	1.77	1.77	2.17	0.34	6.50	Vu < PhiVc/2	lot Reqd 11.4	6.5	0.0	0.0
+1.20D+1.60S+0.50W+1.60H	1	1.05	5.00	1.71	1.71	2.28	0.31	6.48	Vu < PhiVc/2	lot Reqd 11.4	6.5	0.0	0.0
+1.20D+1.60S+0.50W+1.60H	1	1.11	5.00	1.66	1.66	2.39	0.29	6.46	Vu < PhiVc/2	lot Reqd 11.4	6.5	0.0	0.0
+1.20D+1.60S+0.50W+1.60H	1	1.18	5.00	1.60	1.60	2.50	0.27	6.44	Vu < PhiVc/2	lot Reqd 11.4	6.4	0.0	0.0
+1.20D+1.60S+0.50W+1.60H	1	1.25	5.00	1.54	1.54	2.60	0.25	6.43	Vu < PhiVc/2	lot Reqd 11.4	6.4	0.0	0.0
+1.20D+1.60S+0.50W+1.60H	1	1.31	5.00	1.48	1.48	2.70	0.23	6.42	Vu < PhiVc/2	lot Reqd 11.4	6.4	0.0	0.0
+1.20D+1.60S+0.50W+1.60H	1	1.38	5.00	1.43	1.43	2.80	0.21	6.40	Vu < PhiVc/2	lot Reqd 11.4	6.4	0.0	0.0
+1.20D+1.60S+0.50W+1.60H	1	1.44	5.00	1.37	1.37	2.89	0.20	6.39	Vu < PhiVc/2	lot Reqd 11.4	6.4	0.0	0.0
+1.20D+1.60S+0.50W+1.60H	1	1.51	5.00	1.31	1.31	2.98	0.18	6.38	Vu < PhiVc/2	lot Reqd 11.4	6.4	0.0	0.0
+1.20D+1.60S+0.50W+1.60H	1	1.57	5.00	1.25	1.25	3.06	0.17	6.37	Vu < PhiVc/2	lot Reqd 11.4	6.4	0.0	0.0
+1.20D+1.60S+0.50W+1.60H	1	1.64	5.00	1.20	1.20	3.14	0.16	6.36	Vu < PhiVc/2	lot Reqd 11.4	6.4	0.0	0.0
+1.20D+1.60S+0.50W+1.60H	1	1.70	5.00	1.14	1.14	3.22	0.15	6.35	Vu < PhiVc/2	lot Reqd 11.4	6.4	0.0	0.0
+1.20D+1.60S+0.50W+1.60H	1	1.77	5.00	1.08	1.08	3.29	0.14	6.35	Vu < PhiVc/2	lot Reqd 11.4	6.3	0.0	0.0
+1.20D+1.60S+0.50W+1.60H	1	1.84	5.00	1.02	1.02	3.36	0.13	6.34	Vu < PhiVc/2	lot Reqd 11.4	6.3	0.0	0.0
+1.20D+1.60S+0.50W+1.60H	1	1.90	5.00	0.97	0.97	3.42	0.12	6.33	Vu < PhiVc/2	lot Reqd 11.4	6.3	0.0	0.0
+1.20D+1.60S+0.50W+1.60H	1	1.97	5.00	0.91	0.91	3.49	0.11	6.33	Vu < PhiVc/2	lot Reqd 11.4	6.3	0.0	0.0
+1.20D+1.60S+0.50W+1.60H	1	2.03	5.00	0.85	0.85	3.54	0.10	6.32	Vu < PhiVc/2	lot Reqd 11.4	6.3	0.0	0.0
+1.20D+1.60S+0.50W+1.60H	1	2.10	5.00	0.79	0.79	3.60	0.09	6.31	Vu < PhiVc/2	lot Reqd 11.4	6.3	0.0	0.0
+1.20D+1.60S+0.50W+1.60H	1	2.16	5.00	0.73	0.73	3.65	0.08	6.31	Vu < PhiVc/2	lot Reqd 11.4	6.3	0.0	0.0
+1.20D+1.60S+0.50W+1.60H	1	2.23	5.00	0.68	0.68	3.69	0.08	6.30	Vu < PhiVc/2	lot Reqd 11.4	6.3	0.0	0.0
+1.20D+1.60S+0.50W+1.60H	1	2.30	5.00	0.62	0.62	3.74	0.07	6.30	Vu < PhiVc/2	lot Reqd 11.4	6.3	0.0	0.0
+1.20D+1.60S+0.50W+1.60H	1	2.36	5.00	0.56	0.56	3.77	0.06	6.29	Vu < PhiVc/2	lot Reqd 11.4	6.3	0.0	0.0
+1.20D+1.60S+0.50W+1.60H	1	2.43	5.00	0.50	0.50	3.81	0.06	6.29	Vu < PhiVc/2	lot Reqd 11.4	6.3	0.0	0.0
+1.20D+1.60S+0.50W+1.60H	1	2.49	5.00	0.45	0.45	3.84	0.05	6.28	Vu < PhiVc/2	lot Reqd 11.4	6.3	0.0	0.0
+1.20D+1.60S+0.50W+1.60H	1	2.56	5.00	0.39	0.39	3.87	0.04	6.28	Vu < PhiVc/2	lot Reqd 11.4	6.3	0.0	0.0
+1.20D+1.60S+0.50W+1.60H	1	2.62	5.00	0.33	0.33	3.89	0.04	6.27	Vu < PhiVc/2	lot Reqd 11.4	6.3	0.0	0.0
+1.20D+1.60S+0.50W+1.60H	1	2.69	5.00	0.27	0.27	3.91	0.03	6.27	Vu < PhiVc/2	lot Reqd 11.4	6.3	0.0	0.0
+1.20D+1.60S+0.50W+1.60H	1	2.75	5.00	0.22	0.22	3.93	0.02	6.26	Vu < PhiVc/2	lot Reqd 11.4	6.3	0.0	0.0
+1.20D+1.60S+0.50W+1.60H	1	2.82	5.00	0.16	0.16	3.94	0.02	6.26	Vu < PhiVc/2	lot Reqd 11.4	6.3	0.0	0.0
+1.20D+1.60S+0.50W+1.60H	1	2.89	5.00	0.10	0.10	3.95	0.01	6.25	Vu < PhiVc/2	lot Reqd 11.4	6.3	0.0	0.0
+1.20D+1.60S+0.50W+1.60H	1	2.95	5.00	0.04	0.04	3.95	0.00	6.25	Vu < PhiVc/2	lot Reqd 11.4	6.2	0.0	0.0
+1.20D+1.60S+0.50W+1.60H	1	3.02	5.00	-0.01	0.01	3.95	0.00	6.25	Vu < PhiVc/2	lot Reqd 11.4	6.2	0.0	0.0

Concrete Beam

Lic. # : KW-06004787

DESCRIPTION: 8"x16" continuous footing spanning 6' at footing step

Detailed Shear Information

Load Combination	Span Number	Distance (ft)	'd' (in)	Vu (k) Actual	Vu (k) Design	Mu (k-ft)	d*Vu/Mu	Phi*Vc (k)	Comment	Phi*Vs (k)	Phi*Vn (k)	Spacing (in) Req'd Suggest	
+1.20D+1.60S+0.50W+1.60H	1	3.08	5.00	-0.07	0.07	3.95	0.01	6.25	Vu < PhiVc/2	lot Reqd 11.4	6.2	0.0	0.0
+1.20D+1.60S+0.50W+1.60H	1	3.15	5.00	-0.13	0.13	3.94	0.01	6.25	Vu < PhiVc/2	lot Reqd 11.4	6.3	0.0	0.0
+1.20D+1.60S+0.50W+1.60H	1	3.21	5.00	-0.19	0.19	3.93	0.02	6.26	Vu < PhiVc/2	lot Reqd 11.4	6.3	0.0	0.0
+1.20D+1.60S+0.50W+1.60H	1	3.28	5.00	-0.24	0.24	3.92	0.03	6.26	Vu < PhiVc/2	lot Reqd 11.4	6.3	0.0	0.0
+1.20D+1.60S+0.50W+1.60H	1	3.34	5.00	-0.30	0.30	3.90	0.03	6.27	Vu < PhiVc/2	lot Reqd 11.4	6.3	0.0	0.0
+1.20D+1.60S+0.50W+1.60H	1	3.41	5.00	-0.36	0.36	3.88	0.04	6.27	Vu < PhiVc/2	lot Reqd 11.4	6.3	0.0	0.0
+1.20D+1.60S+0.50W+1.60H	1	3.48	5.00	-0.42	0.42	3.85	0.05	6.28	Vu < PhiVc/2	lot Reqd 11.4	6.3	0.0	0.0
+1.20D+1.60S+0.50W+1.60H	1	3.54	5.00	-0.48	0.48	3.83	0.05	6.28	Vu < PhiVc/2	lot Reqd 11.4	6.3	0.0	0.0
+1.20D+1.60S+0.50W+1.60H	1	3.61	5.00	-0.53	0.53	3.79	0.06	6.29	Vu < PhiVc/2	lot Reqd 11.4	6.3	0.0	0.0
+1.20D+1.60S+0.50W+1.60H	1	3.67	5.00	-0.59	0.59	3.76	0.07	6.29	Vu < PhiVc/2	lot Reqd 11.4	6.3	0.0	0.0
+1.20D+1.60S+0.50W+1.60H	1	3.74	5.00	-0.65	0.65	3.71	0.07	6.30	Vu < PhiVc/2	lot Reqd 11.4	6.3	0.0	0.0
+1.20D+1.60S+0.50W+1.60H	1	3.80	5.00	-0.71	0.71	3.67	0.08	6.30	Vu < PhiVc/2	lot Reqd 11.4	6.3	0.0	0.0
+1.20D+1.60S+0.50W+1.60H	1	3.87	5.00	-0.76	0.76	3.62	0.09	6.31	Vu < PhiVc/2	lot Reqd 11.4	6.3	0.0	0.0
+1.20D+1.60S+0.50W+1.60H	1	3.93	5.00	-0.82	0.82	3.57	0.10	6.32	Vu < PhiVc/2	lot Reqd 11.4	6.3	0.0	0.0
+1.20D+1.60S+0.50W+1.60H	1	4.00	5.00	-0.88	0.88	3.51	0.10	6.32	Vu < PhiVc/2	lot Reqd 11.4	6.3	0.0	0.0
+1.20D+1.60S+0.50W+1.60H	1	4.07	5.00	-0.94	0.94	3.46	0.11	6.33	Vu < PhiVc/2	lot Reqd 11.4	6.3	0.0	0.0
+1.20D+1.60S+0.50W+1.60H	1	4.13	5.00	-0.99	0.99	3.39	0.12	6.34	Vu < PhiVc/2	lot Reqd 11.4	6.3	0.0	0.0
+1.20D+1.60S+0.50W+1.60H	1	4.20	5.00	-1.05	1.05	3.32	0.13	6.34	Vu < PhiVc/2	lot Reqd 11.4	6.3	0.0	0.0
+1.20D+1.60S+0.50W+1.60H	1	4.26	5.00	-1.11	1.11	3.25	0.14	6.35	Vu < PhiVc/2	lot Reqd 11.4	6.4	0.0	0.0
+1.20D+1.60S+0.50W+1.60H	1	4.33	5.00	-1.17	1.17	3.18	0.15	6.36	Vu < PhiVc/2	lot Reqd 11.4	6.4	0.0	0.0
+1.20D+1.60S+0.50W+1.60H	1	4.39	5.00	-1.22	1.22	3.10	0.16	6.37	Vu < PhiVc/2	lot Reqd 11.4	6.4	0.0	0.0
+1.20D+1.60S+0.50W+1.60H	1	4.46	5.00	-1.28	1.28	3.02	0.18	6.38	Vu < PhiVc/2	lot Reqd 11.4	6.4	0.0	0.0
+1.20D+1.60S+0.50W+1.60H	1	4.52	5.00	-1.34	1.34	2.93	0.19	6.39	Vu < PhiVc/2	lot Reqd 11.4	6.4	0.0	0.0
+1.20D+1.60S+0.50W+1.60H	1	4.59	5.00	-1.40	1.40	2.84	0.20	6.40	Vu < PhiVc/2	lot Reqd 11.4	6.4	0.0	0.0
+1.20D+1.60S+0.50W+1.60H	1	4.66	5.00	-1.45	1.45	2.75	0.22	6.41	Vu < PhiVc/2	lot Reqd 11.4	6.4	0.0	0.0
+1.20D+1.60S+0.50W+1.60H	1	4.72	5.00	-1.51	1.51	2.65	0.24	6.42	Vu < PhiVc/2	lot Reqd 11.4	6.4	0.0	0.0
+1.20D+1.60S+0.50W+1.60H	1	4.79	5.00	-1.57	1.57	2.55	0.26	6.44	Vu < PhiVc/2	lot Reqd 11.4	6.4	0.0	0.0
+1.20D+1.60S+0.50W+1.60H	1	4.85	5.00	-1.63	1.63	2.45	0.28	6.45	Vu < PhiVc/2	lot Reqd 11.4	6.5	0.0	0.0
+1.20D+1.60S+0.50W+1.60H	1	4.92	5.00	-1.69	1.69	2.34	0.30	6.47	Vu < PhiVc/2	lot Reqd 11.4	6.5	0.0	0.0
+1.20D+1.60S+0.50W+1.60H	1	4.98	5.00	-1.74	1.74	2.23	0.33	6.49	Vu < PhiVc/2	lot Reqd 11.4	6.5	0.0	0.0
+1.20D+1.60S+0.50W+1.60H	1	5.05	5.00	-1.80	1.80	2.11	0.36	6.51	Vu < PhiVc/2	lot Reqd 11.4	6.5	0.0	0.0
+1.20D+1.60S+0.50W+1.60H	1	5.11	5.00	-1.86	1.86	1.99	0.39	6.54	Vu < PhiVc/2	lot Reqd 11.4	6.5	0.0	0.0
+1.20D+1.60S+0.50W+1.60H	1	5.18	5.00	-1.92	1.92	1.87	0.43	6.56	Vu < PhiVc/2	lot Reqd 11.4	6.6	0.0	0.0
+1.20D+1.60S+0.50W+1.60H	1	5.25	5.00	-1.97	1.97	1.74	0.47	6.60	Vu < PhiVc/2	lot Reqd 11.4	6.6	0.0	0.0
+1.20D+1.60S+0.50W+1.60H	1	5.31	5.00	-2.03	2.03	1.61	0.53	6.64	Vu < PhiVc/2	lot Reqd 11.4	6.6	0.0	0.0
+1.20D+1.60S+0.50W+1.60H	1	5.38	5.00	-2.09	2.09	1.47	0.59	6.69	Vu < PhiVc/2	lot Reqd 11.4	6.7	0.0	0.0
+1.20D+1.60S+0.50W+1.60H	1	5.44	5.00	-2.15	2.15	1.33	0.67	6.75	Vu < PhiVc/2	lot Reqd 11.4	6.7	0.0	0.0
+1.20D+1.60S+0.50W+1.60H	1	5.51	5.00	-2.20	2.20	1.19	0.77	6.82	Vu < PhiVc/2	lot Reqd 11.4	6.8	0.0	0.0
+1.20D+1.60S+0.50W+1.60H	1	5.57	5.00	-2.26	2.26	1.04	0.90	6.92	Vu < PhiVc/2	lot Reqd 11.4	6.9	0.0	0.0
+1.20D+1.60S+0.50W+1.60H	1	5.64	5.00	-2.32	2.32	0.89	1.00	6.99	Vu < PhiVc/2	lot Reqd 11.4	7.0	0.0	0.0
+1.20D+1.60S+0.50W+1.60H	1	5.70	5.00	-2.38	2.38	0.74	1.00	6.99	Vu < PhiVc/2	lot Reqd 11.4	7.0	0.0	0.0
+1.20D+1.60S+0.50W+1.60H	1	5.77	5.00	-2.43	2.43	0.58	1.00	6.99	Vu < PhiVc/2	lot Reqd 11.4	7.0	0.0	0.0
+1.20D+1.60S+0.50W+1.60H	1	5.84	5.00	-2.49	2.49	0.42	1.00	6.99	Vu < PhiVc/2	lot Reqd 11.4	7.0	0.0	0.0
+1.20D+1.60S+0.50W+1.60H	1	5.90	5.00	-2.55	2.55	0.26	1.00	6.99	Vu < PhiVc/2	lot Reqd 11.4	7.0	0.0	0.0
+1.20D+1.60S+0.50W+1.60H	1	5.97	5.00	-2.61	2.61	0.09	1.00	6.99	Vu < PhiVc/2	lot Reqd 11.4	7.0	0.0	0.0

Maximum Forces & Stresses for Load Combinations

Load Combination Segment	Span #	Location (ft) along Beam	Bending Stress Results (k-ft)		
			Mu : Max	Phi*Mnx	Stress Ratio
MAXimum BENDING Envelope					
Span # 1	1	6.000	3.95	8.47	0.47
+1.40D+1.60H					
Span # 1	1	6.000	2.51	8.47	0.30
+1.20D+0.50Lr+1.60L+1.60H					
Span # 1	1	6.000	2.15	8.47	0.25
+1.20D+1.60L+0.50S+1.60H					

Concrete Beam

Lic. # : KW-06004787

DESCRIPTION: 8"x16" continuous footing spanning 6' at footing step

Load Combination Segment	Span #	Location (ft) along Beam	Bending Stress Results (k-ft)		
			Mu : Max	Phi*Mnx	Stress Ratio
Span # 1	1	6.000	2.72	8.47	0.32
+1.20D+1.60Lr+L+1.60H					
Span # 1	1	6.000	2.15	8.47	0.25
+1.20D+1.60Lr+0.50W+1.60H					
Span # 1	1	6.000	2.15	8.47	0.25
+1.20D+L+1.60S+1.60H					
Span # 1	1	6.000	3.95	8.47	0.47
+1.20D+1.60S+0.50W+1.60H					
Span # 1	1	6.000	3.95	8.47	0.47
+1.20D+0.50Lr+L+W+1.60H					
Span # 1	1	6.000	2.15	8.47	0.25
+1.20D+L+0.50S+W+1.60H					
Span # 1	1	6.000	2.72	8.47	0.32
+0.90D+W+1.60H					
Span # 1	1	6.000	1.62	8.47	0.19
+1.20D+L+0.20S+E+1.60H					
Span # 1	1	6.000	2.38	8.47	0.28
+0.90D+E+0.90H					
Span # 1	1	6.000	1.62	8.47	0.19

Overall Maximum Deflections

Load Combination	Span	Max. "-" Defl (in)	Location in Span (ft)	Load Combination	Max. "+" Defl (in)	Location in Span (ft)
+D+S+H	1	0.0089	3.000		0.0000	0.000

Use menu item Settings > Printing & Title Block
to set these five lines of information
for your program.

Project Name/Number : shoring wall

Title Foundation Wall at Side of Driveway

Dsgnr: NJD
Description....

Page : 1
Date: 11 MAR 2022

This Wall in File: P:\Client Files\244 - McCullough Architects\2020\20019 - Barcelo Homes - Lot 1 -

RetainPro (c) 1987-2019, Build 11.20.03.31
License : KW-06059959
License To : MULHERN & KULP STRUCTURAL ENGINEERING INC

Cantilevered Retaining Wall

Code: IBC 2018,ACI 318-14,TMS 402-16

Criteria

Retained Height	=	3.50 ft
Wall height above soil	=	0.00 ft
Slope Behind Wall	=	0.00
Height of Soil over Toe	=	12.00 in
Water height over heel	=	0.0 ft

Soil Data

Allow Soil Bearing	=	2,000.0 psf
Equivalent Fluid Pressure Method		
Active Heel Pressure	=	55.0 psf/ft
	=	
Passive Pressure	=	300.0 psf/ft
Soil Density, Heel	=	110.0 pcf
Soil Density, Toe	=	0.00 pcf
Footing Soil Friction	=	0.320
Soil height to ignore for passive pressure	=	12.00 in

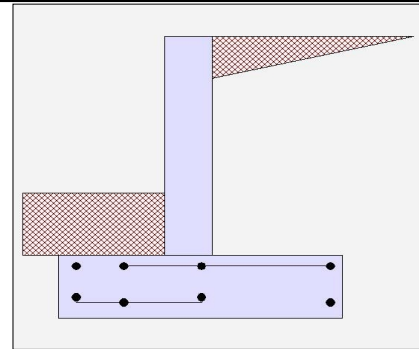

Surcharge Loads

Surcharge Over Heel	=	45.0 psf
Used To Resist Sliding & Overturning		
Surcharge Over Toe	=	0.0
Used for Sliding & Overturning		

Lateral Load Applied to Stem

Lateral Load	=	0.0 #/ft
...Height to Top	=	0.00 ft
...Height to Bottom	=	0.00 ft
Load Type	=	Wind (W) (Service Level)
Wind on Exposed Stem	=	0.0 psf (Service Level)

Adjacent Footing Load

Adjacent Footing Load	=	0.0 lbs
Footing Width	=	0.00 ft
Eccentricity	=	0.00 in
Wall to Ftg CL Dist	=	0.00 ft
Footing Type	=	Line Load
Base Above/Below Soil at Back of Wall	=	0.0 ft
Poisson's Ratio	=	0.300

Axial Load Applied to Stem

Axial Dead Load	=	0.0 lbs
Axial Live Load	=	0.0 lbs
Axial Load Eccentricity	=	0.0 in

Design Summary

Wall Stability Ratios

Overturning	=	4.67 OK
Sliding	=	1.61 OK

Total Bearing Load	=	1,911 lbs
...resultant ecc.	=	2.93 in

Soil Pressure @ Toe	=	275 psf OK
Soil Pressure @ Heel	=	594 psf OK
Allowable	=	2,000 psf
Soil Pressure Less Than Allowable		

ACI Factored @ Toe	=	385 psf
ACI Factored @ Heel	=	831 psf
Footing Shear @ Toe	=	0.6 psi OK
Footing Shear @ Heel	=	2.2 psi OK
Allowable	=	75.0 psi

Sliding Calcs

Lateral Sliding Force	=	658.1 lbs
less 100% Passive Force	= -	450.0 lbs
less 100% Friction Force	= -	611.7 lbs
Added Force Req'd	=	0.0 lbs OK
....for 1.5 Stability	=	0.0 lbs OK

Stem Construction

Design Height Above Ftg	ft =	0.00
Wall Material Above "Ht"	=	Concrete
Design Method	=	LRFD
Thickness	=	8.00
Rebar Size	=	# 5
Rebar Spacing	=	16.00
Rebar Placed at	=	Edge

Design Data

fb/FB + fa/Fa	=	0.137
---------------	---	-------

Total Force @ Section

Service Level	lbs =	
Strength Level	lbs =	665.0

Moment....Actual

Service Level	ft-# =	
Strength Level	ft-# =	849.3

Moment.....Allowable	=	6,186.6
----------------------	---	---------

Shear.....Actual

Service Level	psi =	
Strength Level	psi =	9.0

Shear.....Allowable	psi =	75.0
---------------------	-------	------

Anet (Masonry)	in2 =	
Rebar Depth 'd'	in =	6.19

Masonry Data

f'm	psi =	
Fs	psi =	
Solid Grouting	=	
Modular Ratio 'n'	=	
Wall Weight	psf =	100.0
Short Term Factor	=	
Equiv. Solid Thick.	=	
Masonry Block Type	=	Medium Weight
Masonry Design Method	=	ASD

Concrete Data

f'c	psi =	2,500.0
Fy	psi =	60,000.0

Vertical component of active lateral soil pressure IS considered in the calculation of soil bearing pressures.

Load Factors

Building Code	IBC 2018,ACI
Dead Load	1.200
Live Load	1.600
Earth, H	1.600
Wind, W	1.000
Seismic, E	1.000

Use menu item Settings > Printing & Title Block
to set these five lines of information
for your program.

Project Name/Number : shoring wall
Title Foundation Wall at Side of Driveway
Dsgnr: NJD
Description....

Page : 2
Date: 11 MAR 2022

This Wall in File: P:\Client Files\244 - McCullough Architects\2020\20019 - Barcelo Homes - Lot 1 -

RetainPro (c) 1987-2019, Build 11.20.03.31
License : KW-06059959
License To : MULHERN & KULP STRUCTURAL ENGINEERING INC

Cantilevered Retaining Wall

Code: IBC 2018,ACI 318-14,TMS 402-16

Concrete Stem Rebar Area Details

	Vertical Reinforcing	Horizontal Reinforcing
Bottom Stem		
As (based on applied moment) :	0.0322 in ² /ft	
(4/3) * As :	0.0429 in ² /ft	Min Stem T&S Reinf Area 0.672 in ²
200bd/fy : 200(12)(6.1875)/60000 :	0.2475 in ² /ft	Min Stem T&S Reinf Area per ft of stem Height : 0.192 in ² /ft
0.0018bh : 0.0018(12)(8) :	0.1728 in ² /ft	Horizontal Reinforcing Options :
	=====	One layer of : Two layers of :
Required Area :	0.1728 in ² /ft	#4@ 12.50 in #4@ 25.00 in
Provided Area :	0.2325 in ² /ft	#5@ 19.38 in #5@ 38.75 in
Maximum Area :	0.8382 in ² /ft	#6@ 27.50 in #6@ 55.00 in

Footing Data

Toe Width	=	1.50 ft
Heel Width	=	2.50
Total Footing Width	=	4.00
Footing Thickness	=	12.00 in
Key Width	=	0.00 in
Key Depth	=	0.00 in
Key Distance from Toe	=	0.00 ft
f'c =	2,500 psi	Fy = 60,000 psi
Footing Concrete Density	=	150.00 pcf
Min. As %	=	0.0018
Cover @ Top	2.00	@ Btm= 3.00 in

Footing Design Results

	Toe	Heel
Factored Pressure	= 385	831 psf
Mu' : Upward	= 5,955	1,241 ft-#
Mu' : Downward	= 4,212	1,708 ft-#
Mu: Design	= 145	466 ft-#
Actual 1-Way Shear	= 0.57	2.18 psi
Allow 1-Way Shear	= 75.00	75.00 psi
Toe Reinforcing	= # 4 @ 9.00 in	
Heel Reinforcing	= # 4 @ 9.00 in	
Key Reinforcing	= None Spec'd	
Footing Torsion, Tu	=	0.00 ft-lbs
Footing Allow. Torsion, phi Tu	=	0.00 ft-lbs

If torsion exceeds allowable, provide supplemental design for footing torsion.

Other Acceptable Sizes & Spacings

Toe: #4@ 9.25 in, #5@ 14.35 in, #6@ 20.37 in, #7@ 27.77 in, #8@ 36.57 in, #9@ 46
Heel: #4@ 9.25 in, #5@ 14.35 in, #6@ 20.37 in, #7@ 27.77 in, #8@ 36.57 in, #9@ 46
Key: No key defined

Min footing T&S reinf Area	1.04	in ²
Min footing T&S reinf Area per foot	0.26	in ² /ft
If one layer of horizontal bars:		If two layers of horizontal bars:
#4@ 9.26 in		#4@ 18.52 in
#5@ 14.35 in		#5@ 28.70 in
#6@ 20.37 in		#6@ 40.74 in

Use menu item Settings > Printing & Title Block
to set these five lines of information
for your program.

Project Name/Number : shoring wall

Title Foundation Wall at Side of Driveway

Dsgnr: NJD
Description....

Page : 3
Date: 11 MAR 2022

This Wall in File: P:\Client Files\244 - McCullough Architects\2020\20019 - Barcelo Homes - Lot 1 -

RetainPro (c) 1987-2019, Build 11.20.03.31
License : KW-06059959
License To : MULHERN & KULP STRUCTURAL ENGINEERING INC

Cantilevered Retaining Wall

Code: IBC 2018,ACI 318-14,TMS 402-16

Summary of Overturning & Resisting Forces & Moments

ItemOVERTURNING.....			RESISTING.....		
	Force lbs	Distance ft	Moment ft-#		Force lbs	Distance ft	Moment ft-#
HL Act Pres (ab water tbl)	556.9	1.50	835.3	Soil Over HL (ab. water tbl)	705.8	3.08	2,176.3
HL Act Pres (be water tbl)				Soil Over HL (bel. water tbl)		3.08	2,176.3
Hydrostatic Force				Watre Table			
Buoyant Force =				Sloped Soil Over Heel =			
Surcharge over Heel =	101.3	2.25	227.8	Surcharge Over Heel =	82.5	3.08	254.4
Surcharge Over Toe =				Adjacent Footing Load =			
Adjacent Footing Load =				Axial Dead Load on Stem =			
Added Lateral Load =				* Axial Live Load on Stem =			
Load @ Stem Above Soil =				Soil Over Toe =		0.75	
=				Surcharge Over Toe =			
Total	= 658.1	O.T.M. =	1,063.1	Stem Weight(s) =	350.0	1.83	641.7
				Earth @ Stem Transitions =			
				Footing Weight =	600.0	2.00	1,200.0
				Key Weight =			
Resisting/Overturning Ratio		= 4.67		Vert. Component =	173.1	4.00	692.3
Vertical Loads used for Soil Pressure =		1,911.4 lbs		Total =	1,911.4 lbs	R.M.=	4,964.7

* Axial live load NOT included in total displayed, or used for overturning resistance, but is included for soil pressure calculation.

Vertical component of active lateral soil pressure IS considered in the calculation of Sliding Resistance.

Vertical component of active lateral soil pressure IS considered in the calculation of Overturning Resistance.

Tilt

Horizontal Deflection at Top of Wall due to settlement of soil

(Deflection due to wall bending not considered)

Soil Spring Reaction Modulus 250.0 pci

Horizontal Defl @ Top of Wall (approximate only) 0.000 in

The above calculation is not valid if the heel soil bearing pressure exceeds that of the toe, because the wall would then tend to rotate into the retained soil.

Use menu item Settings > Printing & Title Block
to set these five lines of information
for your program.

Project Name/Number : shoring wall

Title **Pile #19**
Dsgnr: **Project Designer...**
Description....

Page : 1
Date: 4 MAR 2022

This Wall in File: p:\client files\244 - mccullough architects\2020\20019 - barcelo homes - lot 1 -

RetainPro (c) 1987-2019, Build 11.20.03.31
License : KW-06059959
License To : MULHERN & KULP STRUCTURAL ENGINEERING INC

Soldier Pile Retaining Wall

Code: IBC 2018,AISC 360-16

Design Parameters

Wall height (retained height) 7.00 ft
Backfill slope 45.00 deg
Soil Density 110.00 pcf
Soil Phi angle deg

Surcharge top of soil @ retained 0 psf
Allow. Passive 350 psf / ft
Apply S.F. to Passive 1.0
Pile Spacing 6.0 ft
Drilled Diameter, in. 30.00 in
Multiplier to Passive Wedge 2.00
Required Embedment 9.21 ft
Total Pile Embedment 12.00 ft
Soldier Beam Selection W18x35
Lagging Depth 7.00 ft
Lagging Selection 6x12
Steel Design Method ASD
Lateral Pressure Method EPF
Passive Pressure to Neglect 24.00 in
0
Tieback Location None
Steel Fy 36 ksi
Consider pile fully-braced for lateral torsional buckling

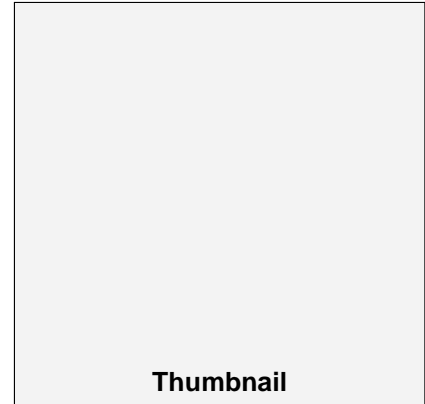

Design Results

Required embedment 9.21 ft 9.21ft = 7.21 + 2 ft neglected
Embedment Used ft
Deflection at top of pile 0.02 in

Pile Pw 0 lb
Pile Total Lateral 8,085 lb

Depth to Max M 1.64 ft
Mmax in Pile (Service) 27,553 ft-lbs
Vmax in Pile (Service) 8,085 lb

Status Checks

				<u>Ratio</u>	<u>Status</u>
Ma	27,553 ft-lbs	Mn/Omega	119,461 ft-lbs	0.23	OK
Va	8,085 lb	Vn/Omega	76,464 lb	0.11	OK
Embedment Required					OK

Use menu item Settings > Printing & Title Block
to set these five lines of information
for your program.

Project Name/Number : shoring wall

Title **Pile #20**
Dsgnr: **Project Designer...**
Description....

Page : 1
Date: 4 MAR 2022

This Wall in File: p:\client files\244 - mccullough architects\2020\20019 - barcelo homes - lot 1 -

RetainPro (c) 1987-2019, Build 11.20.03.31
License : KW-06059959
License To : MULHERN & KULP STRUCTURAL ENGINEERING INC

Soldier Pile Retaining Wall

Code: IBC 2018,AISC 360-16

Design Parameters

Wall height (retained height) 1.00 ft
Backfill slope 45.00 deg
Soil Density 110.00 pcf
Soil Phi angle deg

Surcharge top of soil @ retained 0 psf
Allow. Passive 350 psf / ft
Apply S.F. to Passive 1.0
Pile Spacing 6.0 ft
Drilled Diameter, in. 30.00 in
Multiplier to Passive Wedge 2.00
Required Embedment 2.14 ft
Total Pile Embedment 4.00 ft
Soldier Beam Selection W18x35
Lagging Depth 1.00 ft
Lagging Selection 6x12
Steel Design Method ASD
Lateral Pressure Method EPF
Passive Pressure to Neglect 24.00 in
0
Tieback Location None
Steel Fy 36 ksi
Consider pile fully-braced for lateral torsional buckling



Design Results

Required embedment 2.14 ft 2.14ft = 0.14 + 2 ft neglected
Embedment Used ft
Deflection at top of pile 0.00 in

Pile Pw 0 lb
Pile Total Lateral 165 lb

Depth to Max M 0.05 ft
Mmax in Pile (Service) 60 ft-lbs
Vmax in Pile (Service) 165 lb

Status Checks

				<u>Ratio</u>	<u>Status</u>
Ma	60 ft-lbs	Mn/Omega	119,461 ft-lbs	0.00	OK
Va	165 lb	Vn/Omega	76,464 lb	0.00	OK
Embedment Required					OK

Use menu item Settings > Printing & Title Block
to set these five lines of information
for your program.

Project Name/Number : shoring wall

Title **Pile #1**
Dsgnr: **Project Designer...**
Description....

Page : 1
Date: 4 MAR 2022

This Wall in File: P:\Client Files\244 - McCullough Architects\2020\20019 - Barcelo Homes - Lot 1 -

RetainPro (c) 1987-2019, Build 11.20.03.31
License : KW-06059959
License To : MULHERN & KULP STRUCTURAL ENGINEERING INC

Soldier Pile Retaining Wall

Code: IBC 2018,AISC 360-16

Design Parameters

Wall height (retained height) 5.00 ft
 Backfill slope 45.00 deg
 Soil Density 110.00 pcf
 Soil Phi angle deg

 Surcharge top of soil @ retained 0 psf
 Allow. Passive 350 psf / ft
 Apply S.F. to Passive 1.0
 Pile Spacing 6.0 ft
 Drilled Diameter, in. 30.00 in
 Multiplier to Passive Wedge 2.00
 Required Embedment 6.77 ft
 Total Pile Embedment 8.00 ft
 Soldier Beam Selection W18x35
 Lagging Depth 2.50 ft
 Lagging Selection 6x12
Steel Design Method ASD
 Lateral Pressure Method EPF
 Passive Pressure to Neglect 24.00 in
 0
 Tieback Location None
 Steel Fy 36 ksi
 Consider pile fully-braced for lateral torsional buckling



Design Results

Required embedment 6.77 ft 6.77ft = 4.77 + 2 ft neglected
 Embedment Used ft
 Deflection at top of pile 0.00 in

Pile Pw 0 lb
 Pile Total Lateral 4,125 lb

Status Checks

Depth to Max M 0.95 ft
 Mmax in Pile (Service) 9,437 ft-lbs
 Vmax in Pile (Service) 4,125 lb

				<u>Ratio</u>	<u>Status</u>
Ma	9,437 ft-lbs	Mn/Omega	119,461 ft-lbs	0.08	OK
Va	4,125 lb	Vn/Omega	76,464 lb	0.05	OK
Embedment Required					OK

Use menu item Settings > Printing & Title Block
to set these five lines of information
for your program.

Project Name/Number : shoring wall

Title **Pile #2**
Dsgnr: **Project Designer...**
Description....

Page : 1
Date: 4 MAR 2022

This Wall in File: P:\Client Files\244 - McCullough Architects\2020\20019 - Barcelo Homes - Lot 1 -

RetainPro (c) 1987-2019, Build 11.20.03.31
License : KW-06059959
License To : MULHERN & KULP STRUCTURAL ENGINEERING INC

Soldier Pile Retaining Wall

Code: IBC 2018,AISC 360-16

Design Parameters

Wall height (retained height) 11.00 ft
 Backfill slope 45.00 deg
 Soil Density 110.00 pcf
 Soil Phi angle deg

 Surcharge top of soil @ retained 0 psf
 Allow. Passive 350 psf / ft
 Apply S.F. to Passive 1.0
 Pile Spacing 6.0 ft
 Drilled Diameter, in. 30.00 in
 Multiplier to Passive Wedge 2.00
 Required Embedment 14.29 ft
 Total Pile Embedment 17.00 ft
 Soldier Beam Selection W18x35
 Lagging Depth 11.00 ft
 Lagging Selection 6x12
Steel Design Method ASD
 Lateral Pressure Method EPF
 Passive Pressure to Neglect 24.00 in
 0
 Tieback Location None
 Steel Fy 36 ksi
 Consider pile fully-braced for lateral torsional buckling



Design Results

Required embedment 14.29 ft 14.29ft = 12.29 + 2 ft neglecte
 Embedment Used ft
 Deflection at top of pile 0.21 in

Pile Pw 0 lb
 Pile Total Lateral 19,965 lb

Status Checks

Depth to Max M 3.18 ft
 Mmax in Pile (Service) 114,991 ft-lbs
 Vmax in Pile (Service) 19,965 lb

				Ratio	Status
Ma	114,991 ft-lbs	Mn/Omega	119,461 ft-lbs	0.96	OK
Va	19,965 lb	Vn/Omega	76,464 lb	0.26	OK
Embedment Required					OK

Use menu item Settings > Printing & Title Block
to set these five lines of information
for your program.

Project Name/Number : shoring wall

Title **Pile #3-18**
Dsgnr: **Project Designer...**
Description....

Page : 1
Date: 4 MAR 2022

This Wall in File: P:\Client Files\244 - McCullough Architects\2020\20019 - Barcelo Homes - Lot 1 -

RetainPro (c) 1987-2019, Build 11.20.03.31
License : KW-06059959
License To : MULHERN & KULP STRUCTURAL ENGINEERING INC

Soldier Pile Retaining Wall

Code: IBC 2018,AISC 360-16

Design Parameters

Wall height (retained height) 15.00 ft
 Backfill slope 45.00 deg
 Soil Density 110.00 pcf
 Soil Phi angle deg

 Surcharge top of soil @ retained 0 psf
 Allow. Passive 350 psf / ft
 Apply S.F. to Passive 1.0
 Pile Spacing 6.0 ft
 Drilled Diameter, in. 30.00 in
 Multiplier to Passive Wedge 2.00
 Required Embedment 19.48 ft
 Total Pile Embedment 25.00 ft
 Soldier Beam Selection W18x86
 Lagging Depth 15.00 ft
 Lagging Selection 6x12
Steel Design Method ASD
 Lateral Pressure Method EPF
 Passive Pressure to Neglect 24.00 in
 0
 Tieback Location None
 Steel Fy 36 ksi
 Consider pile fully-braced for lateral torsional buckling



Design Results

Required embedment 19.48 ft 19.48ft = 17.48 + 2 ft neglecte
 Embedment Used ft
 Deflection at top of pile 0.33 in

Pile Pw 0 lb
 Pile Total Lateral 37,125 lb

Status Checks

Depth to Max M 4.81 ft
 Mmax in Pile (Service) 303,507 ft-lbs
 Vmax in Pile (Service) 37,125 lb

				<u>Ratio</u>	<u>Status</u>
Ma	303,507 ft-lbs	Mn/Omega	334,132 ft-lbs	0.91	OK
Va	37,125 lb	Vn/Omega	127,181 lb	0.29	OK
Embedment Required					OK

Use menu item Settings > Printing & Title Block
to set these five lines of information
for your program.

Project Name/Number : shoring wall
Title Foundation Wall at Side of Driveway
Dsgnr: NJD
Description....

Page : 1
Date: 11 MAR 2022

This Wall in File: p:\client files\244 - mccullough architects\2020\20019 - barcelo homes - lot 1 -

RetainPro (c) 1987-2019, Build 11.20.03.31
License : KW-06059959
License To : MULHERN & KULP STRUCTURAL ENGINEERING INC

Cantilevered Retaining Wall

Code: IBC 2018,ACI 318-14,TMS 402-16

Criteria

Retained Height	=	4.50 ft
Wall height above soil	=	0.00 ft
Slope Behind Wall	=	0.00
Height of Soil over Toe	=	12.00 in
Water height over heel	=	0.0 ft

Soil Data

Allow Soil Bearing	=	2,000.0 psf
Equivalent Fluid Pressure Method		
Active Heel Pressure	=	55.0 psf/ft
Passive Pressure	=	300.0 psf/ft
Soil Density, Heel	=	110.00 pcf
Soil Density, Toe	=	110.00 pcf
Footings Soil Friction	=	0.320
Soil height to ignore for passive pressure	=	12.00 in

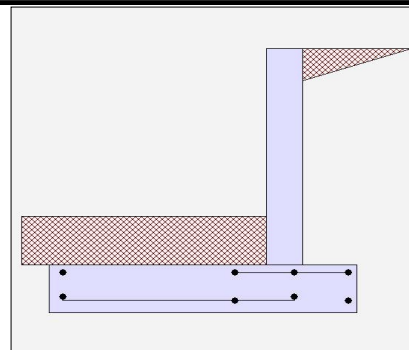

Surcharge Loads

Surcharge Over Heel	=	0.0 psf
Used To Resist Sliding & Overturning		
Surcharge Over Toe	=	0.0
Used for Sliding & Overturning		

Lateral Load Applied to Stem

Lateral Load	=	0.0 #/ft
...Height to Top	=	0.00 ft
...Height to Bottom	=	0.00 ft
Load Type	=	Wind (W) (Service Level)
Wind on Exposed Stem	=	0.0 psf (Service Level)

Adjacent Footing Load

Adjacent Footing Load	=	0.0 lbs
Footing Width	=	0.00 ft
Eccentricity	=	0.00 in
Wall to Ftg CL Dist	=	0.00 ft
Footing Type		Line Load
Base Above/Below Soil at Back of Wall	=	0.0 ft
Poisson's Ratio	=	0.300

Axial Load Applied to Stem

Axial Dead Load	=	0.0 lbs
Axial Live Load	=	0.0 lbs
Axial Load Eccentricity	=	0.0 in

Design Summary

Wall Stability Ratios

Overturning	=	6.08 OK
Sliding	=	1.50 OK
Total Bearing Load	=	2,496 lbs
...resultant ecc.	=	7.54 in
Soil Pressure @ Toe	=	132 psf OK
Soil Pressure @ Heel	=	657 psf OK
Allowable	=	2,000 psf
Soil Pressure Less Than Allowable		
ACI Factored @ Toe	=	185 psf
ACI Factored @ Heel	=	920 psf
Footing Shear @ Toe	=	1.4 psi OK
Footing Shear @ Heel	=	2.9 psi OK
Allowable	=	75.0 psi

Sliding Calcs

Lateral Sliding Force	=	831.9 lbs
less 100% Passive Force	= -	450.0 lbs
less 100% Friction Force	= -	798.6 lbs
Added Force Req'd	=	0.0 lbs OK
....for 1.5 Stability	=	0.0 lbs OK

Vertical component of active lateral soil pressure IS considered in the calculation of soil bearing pressures.

Load Factors

Building Code	IBC 2018,ACI
Dead Load	1.200
Live Load	1.600
Earth, H	1.600
Wind, W	1.000
Seismic, E	1.000

Stem Construction

Design Height Above Ftg	ft =	0.00
Wall Material Above "Ht"	=	Concrete
Design Method	=	LRFD
Thickness	=	8.00
Rebar Size	=	# 5
Rebar Spacing	=	16.00
Rebar Placed at	=	Edge

Design Data

fb/FB + fa/Fa	=	0.216
---------------	---	-------

Total Force @ Section

Service Level	lbs =	
Strength Level	lbs =	891.0

Moment....Actual

Service Level	ft-# =	
Strength Level	ft-# =	1,336.5
Moment....Allowable	=	6,186.6

Shear....Actual

Service Level	psi =	
Strength Level	psi =	12.0
Shear....Allowable	psi =	75.0
Anet (Masonry)	in2 =	
Rebar Depth 'd'	in =	6.19

Masonry Data

f'm	psi =	
Fs	psi =	
Solid Grouting	=	
Modular Ratio 'n'	=	
Wall Weight	psf =	100.0
Short Term Factor	=	
Equiv. Solid Thick.	=	
Masonry Block Type	=	Medium Weight
Masonry Design Method	=	ASD

Concrete Data

f'c	psi =	2,500.0
Fy	psi =	60,000.0

Bottom

Stem OK

Use menu item Settings > Printing & Title Block
to set these five lines of information
for your program.

Project Name/Number : shoring wall

Title Foundation Wall at Side of Driveway
Dsgnr: NJD
Description....

Page : 2
Date: 11 MAR 2022

This Wall in File: p:\client files\244 - mccullough architects\2020\20019 - barcelo homes - lot 1 -

RetainPro (c) 1987-2019, Build 11.20.03.31
License : KW-06059959
License To : MULHERN & KULP STRUCTURAL ENGINEERING INC

Cantilevered Retaining Wall

Code: IBC 2018,ACI 318-14,TMS 402-16

Concrete Stem Rebar Area Details

Bottom Stem	Vertical Reinforcing	Horizontal Reinforcing	
As (based on applied moment) :	0.0506 in ² /ft		
(4/3) * As :	0.0675 in ² /ft	Min Stem T&S Reinf Area 0.864 in ²	
200bd/ft : 200(12)(6.1875)/60000 :	0.2475 in ² /ft	Min Stem T&S Reinf Area per ft of stem Height : 0.192 in ² /ft	
0.0018bh : 0.0018(12)(8) :	0.1728 in ² /ft	Horizontal Reinforcing Options :	
	=====	One layer of : Two layers of :	
Required Area :	0.1728 in ² /ft	#4@ 12.50 in	#4@ 25.00 in
Provided Area :	0.2325 in ² /ft	#5@ 19.38 in	#5@ 38.75 in
Maximum Area :	0.8382 in ² /ft	#6@ 27.50 in	#6@ 55.00 in

Footing Data

Toe Width	=	4.00 ft
Heel Width	=	1.67
Total Footing Width	=	5.67
Footing Thickness	=	12.00 in
Key Width	=	0.00 in
Key Depth	=	0.00 in
Key Distance from Toe	=	0.00 ft
f'c =	2,500 psi	Fy = 60,000 psi
Footing Concrete Density	=	150.00 pcf
Min. As %	=	0.0018
Cover @ Top	2.00	@ Btm.= 3.00 in

Footing Design Results

		<u>Toe</u>	<u>Heel</u>
Factored Pressure	=	185	920 psf
Mu' : Upward	=	34,341	572 ft-#
Mu' : Downward	=	29,952	805 ft-#
Mu: Design	=	366	233 ft-#
Actual 1-Way Shear	=	1.36	2.92 psi
Allow 1-Way Shear	=	75.00	75.00 psi
Toe Reinforcing	=	# 4 @ 9.00 in	
Heel Reinforcing	=	# 4 @ 9.00 in	
Key Reinforcing	=	None Spec'd	
Footing Torsion, Tu	=		0.00 ft-lbs
Footing Allow. Torsion, phi Tu	=		0.00 ft-lbs

If torsion exceeds allowable, provide supplemental design for footing torsion.

Other Acceptable Sizes & Spacings

Toe: #4@ 9.25 in, #5@ 14.35 in, #6@ 20.37 in, #7@ 27.77 in, #8@ 36.57 in, #9@ 46
Heel: #4@ 9.25 in, #5@ 14.35 in, #6@ 20.37 in, #7@ 27.77 in, #8@ 36.57 in, #9@ 46
Key: No key defined

Min footing T&S reinf Area	1.47	in ²
Min footing T&S reinf Area per foot	0.26	in ² /ft
If one layer of horizontal bars:		If two layers of horizontal bars:
#4@ 9.26 in		#4@ 18.52 in
#5@ 14.35 in		#5@ 28.70 in
#6@ 20.37 in		#6@ 40.74 in

